

CARTELLA
FINITURE
AD EFFETTO
METALLO E
MARMO PER
ALLUMINIO



BRUNELLO[®]

SERRAMENTI dal 1975

PROGETTAZIONE - PRODUZIONE - INSTALLAZIONE
ALLUMINIO - PVC - ALLUMINIO/LEGNO

www.brunello serramenti.it

In questa cartella colori, abbiamo riunito tutte le finiture applicabili sui profili e sulle lamiera in alluminio, in grado di riprodurre particolari **effetti metallici** ed **effetti marmo**.
Tutte le finiture di seguito rappresentate sono utilizzabili in ambienti esterni, grazie alla loro elevata resistenza ai raggi UV.

A seguito di una attenta selezione delle migliori materie prime e delle migliori aziende di verniciatura, siamo in grado di offrire ad architetti e designer, accattivanti soluzioni estetiche per tutto ciò che è in alluminio, soprattutto per serramenti e rivestimenti di facciata o interni.
Tutti i tipi di finitura vengono eseguiti secondo i trattamenti previsti dalle più severe normative europee consentendo perciò al cliente di acquistare un prodotto le cui caratteristiche rimangono inalterate per moltissimi anni.

Le finiture di seguito riportate devono essere considerate come indicative in quanto possono variare per ragioni tecniche e di tolleranza.

Per alcune finiture sono previste delle quantità minime di materiale.

È vietata la riproduzione, anche parziale, dei contenuti della presente cartella, senza il consenso scritto di Brunello Innovations Technology s.a.s.

Le finiture di seguito riassunte sono ottenute tramite diversi procedimenti/trattamenti:

- Ossidazione
- Verniciatura a polvere e successivi trattamenti fisici
- Verniciatura con decorazione “polvere su polvere”
- Verniciatura con decorazione tramite “sublimazione” (disponibili diverse categorie)

Nel caso di richiesta preventivi o per ordini, citare **il numero** e **il nome** riportato sotto all'immagine della finitura desiderata.

Sono inoltre disponibili linee di profili per serramenti in alluminio a taglio termico, che richiamano i tradizionali infissi in ferro e acciaio.

Si può anche realizzare il rivestimento dell'edificio con la stessa finiture dei serramenti.

NOVITÀ !!!

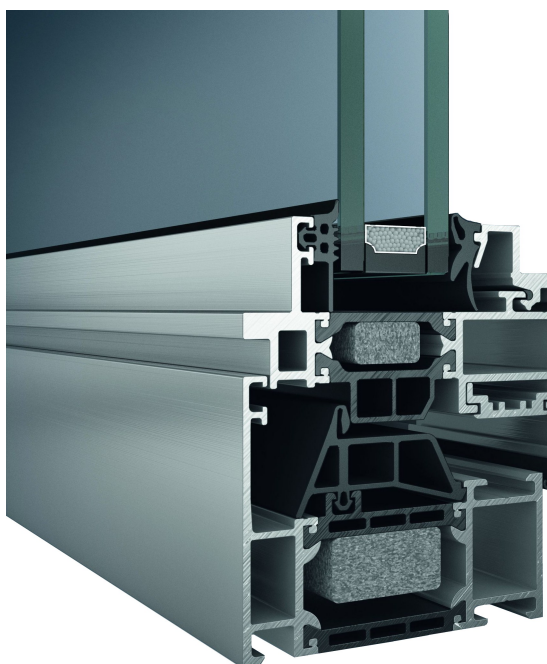

PRINCIPALI APPLICAZIONI (come per le finiture ad effetto legno):

- Serramenti in alluminio (finestre, porte, portoni, scuri, persiane ecc.)



- Rivestimenti ed arredamenti interni, boiserie



- Arredo urbano (panchine, parapetti, ringhiere)



- Rivestimenti esterni e di facciata, tetti e grondaie



**EFFETTI OTTENUTI TRAMITE
OSSIDAZIONE**



1) Titanio Spazzolato



2) Titanio Chimico

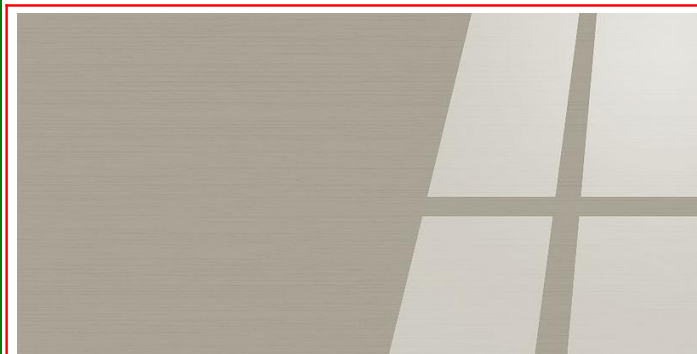

3) Titanio Lucido



4) Titanio Repasado



5) Oro Chiaro Brillante



6) Oro Medio Brillante



7) Oro Scuro Brillante



8) Titanio Chiaro Brillante



9) Titanio Medio Brillante



10) Titanio Scuro Brillante

**EFFETTI OTTENUTI TRAMITE
VERNICIATURA A POLVERE E SUCCESSIVI TRATTAMENTI FISICI**



1) Grigio Ferro Raggrinzato 01

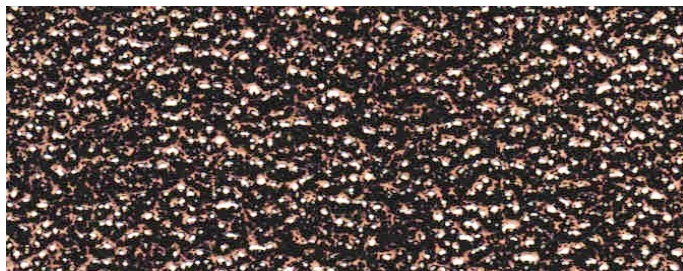

2) Rame Nero Bugnato



3) Nero Bugnato



4) Rame Bugnato



5) Verde Bugnato



6) Oro Nero Bugnato



7) Rame Perlato

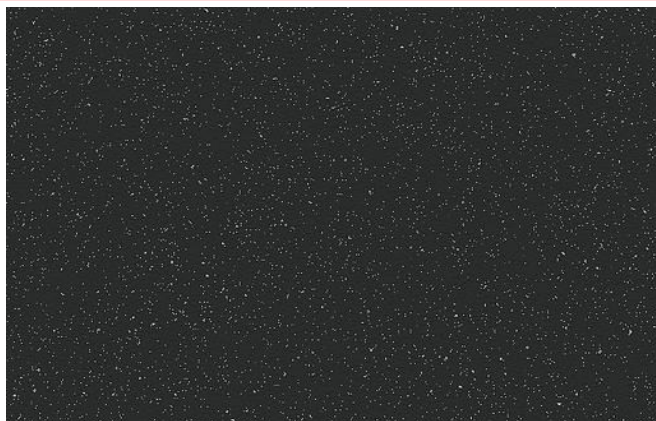

8) Sablè Antracite



9) Sablè Ruggine

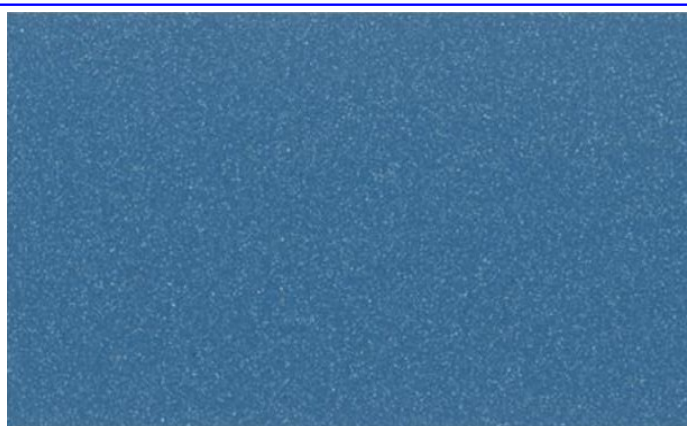

10) Azzurro Marmo

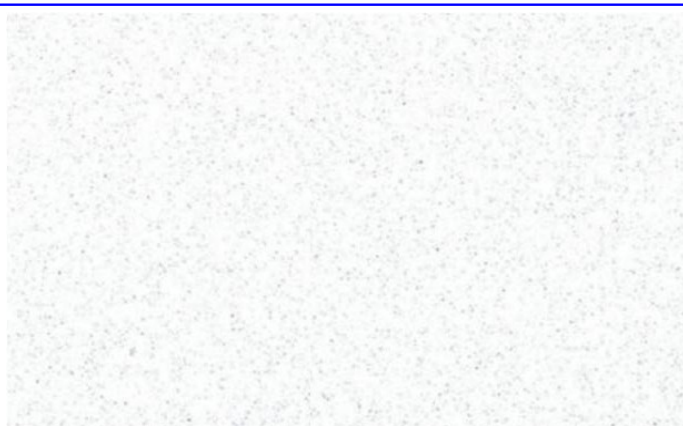

11) Bianco Marmo



12) Grigio Marmo

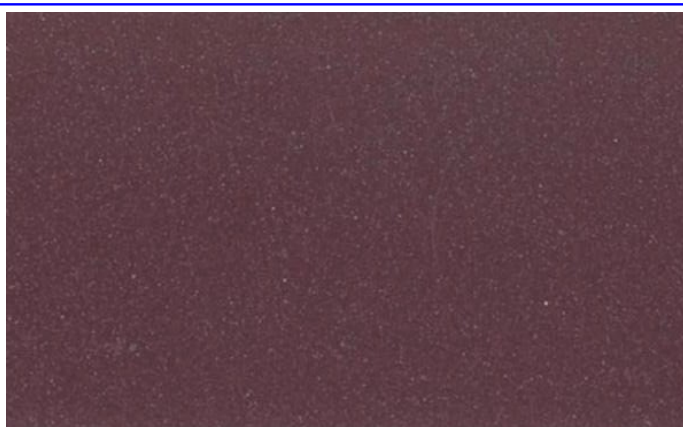

13) Rosso Marmo



14) Verde Marmo

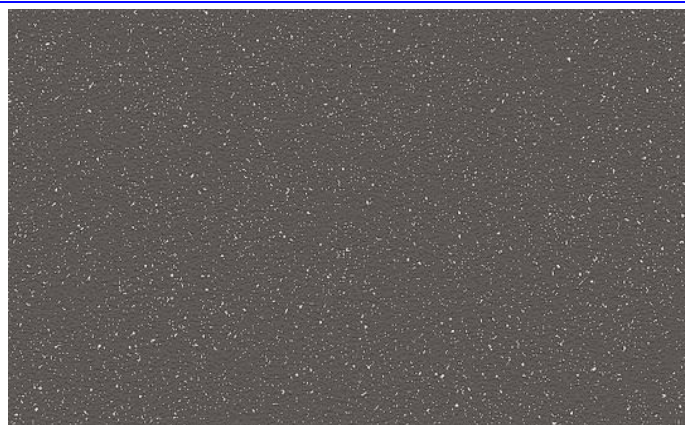

15) Grigio Marmo Raggrinzato



16) Marrone Marmo Raggrinzato

**EFFETTI OTTENUTI TRAMITE
VERNICIATURA CON DECORAZIONE "POLVERE SU POLVERE"**



1) Corten 30



2) Ferro Grigio 40

**EFFETTI OTTENUTI TRAMITE
VERNICIATURA CON DECORAZIONE TRAMITE "SUBLIMAZIONE"**



1) Rame 1



2) Ruggine 1



3) Acciaio Imbrunito



4) Acciaio Chiaro

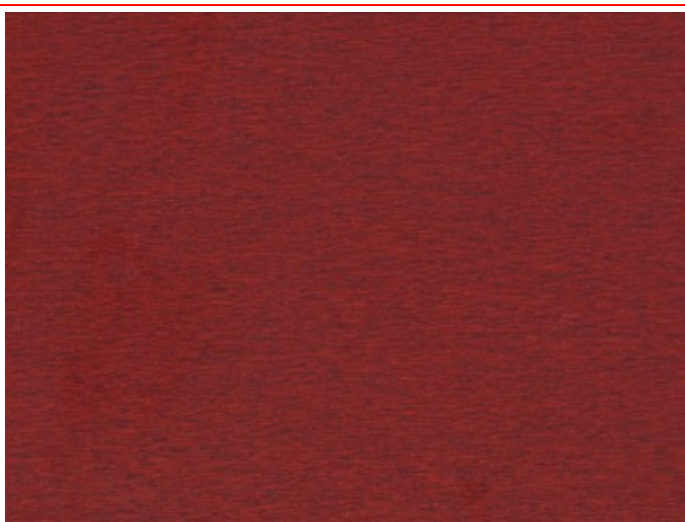

5) Spazzolato Rosso

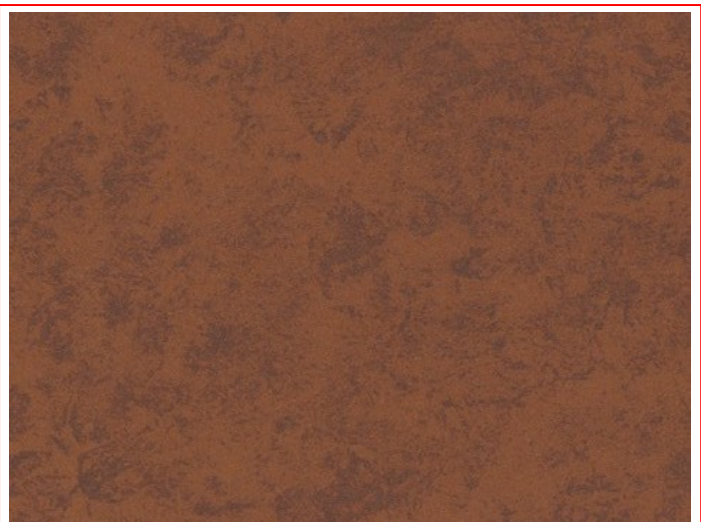

6) Rame Scuro

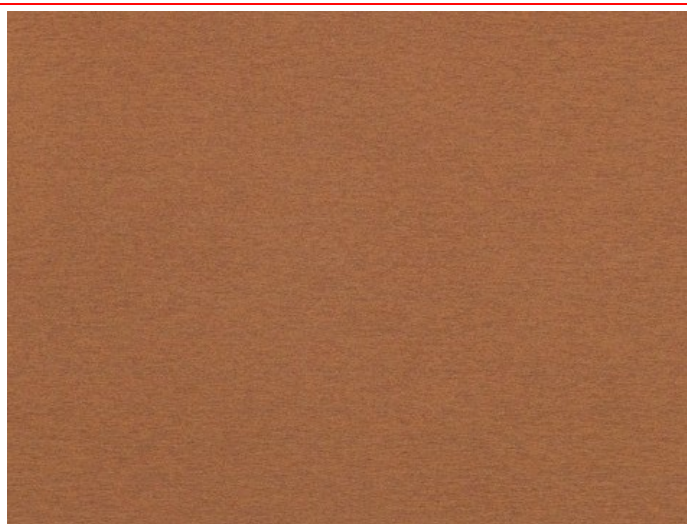

7) Rame Spazzolato

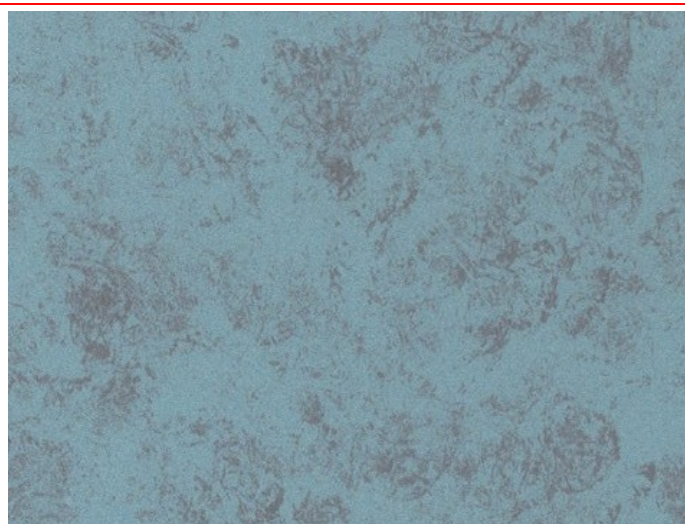

8) Verderame

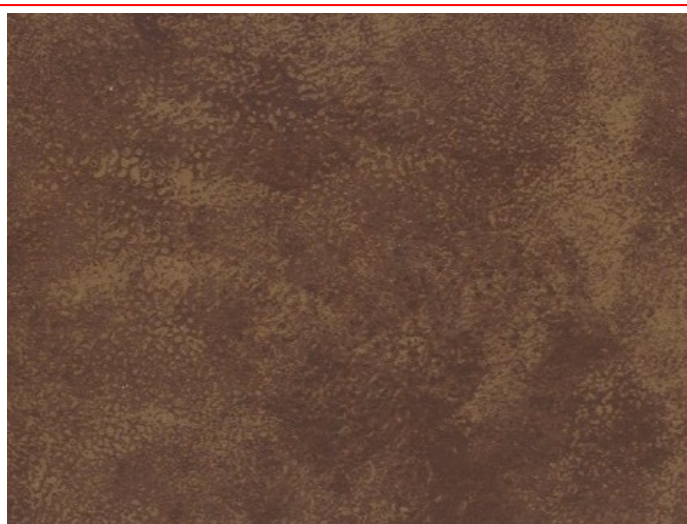

9) Ruggine 2

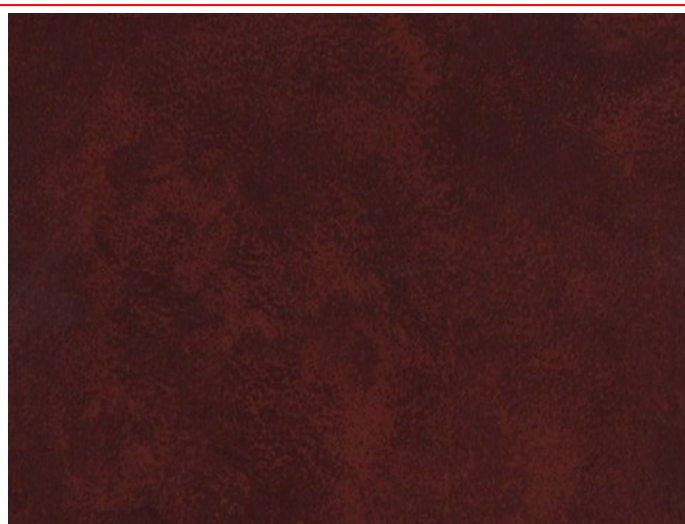

10) Ruggine Rossa

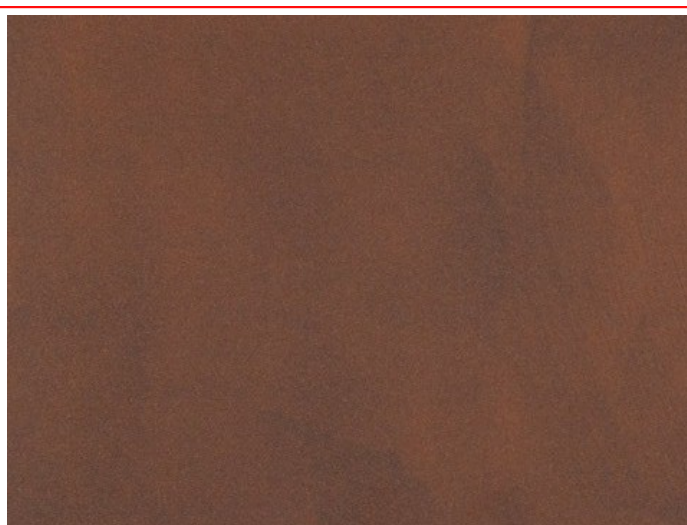

11) Rame Spatolato

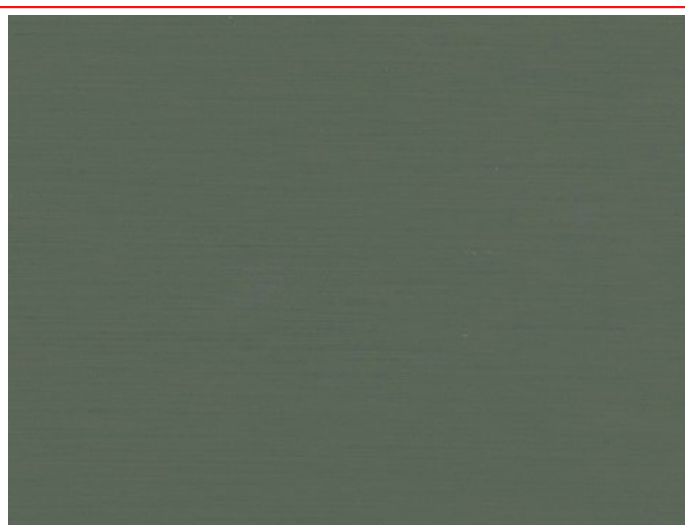

12) Spazzolato



13) Corten 1



14) Corten 2

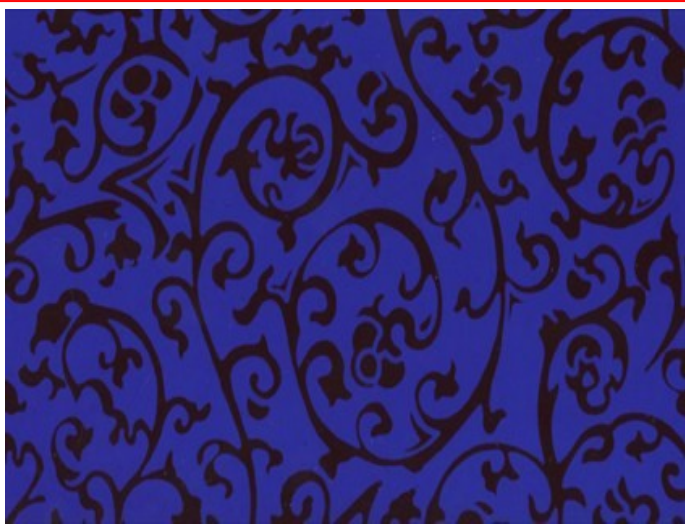

15) Fantasy Vetro



16) Acidato Argento

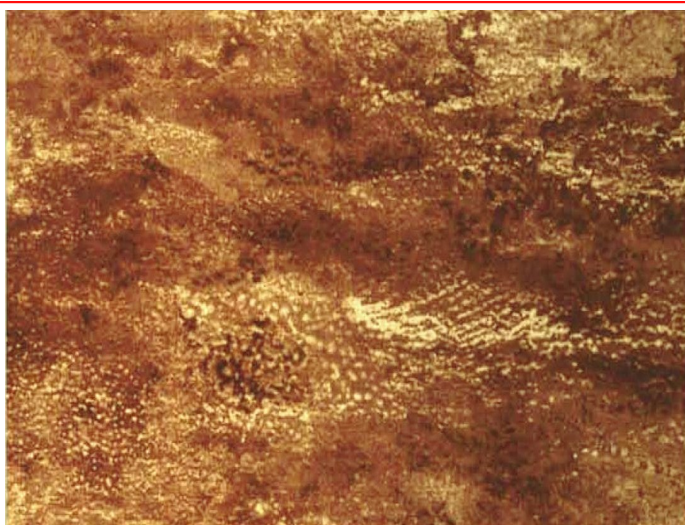

17) Acidato Oro



18) Acidato Rame



19) Ghisa

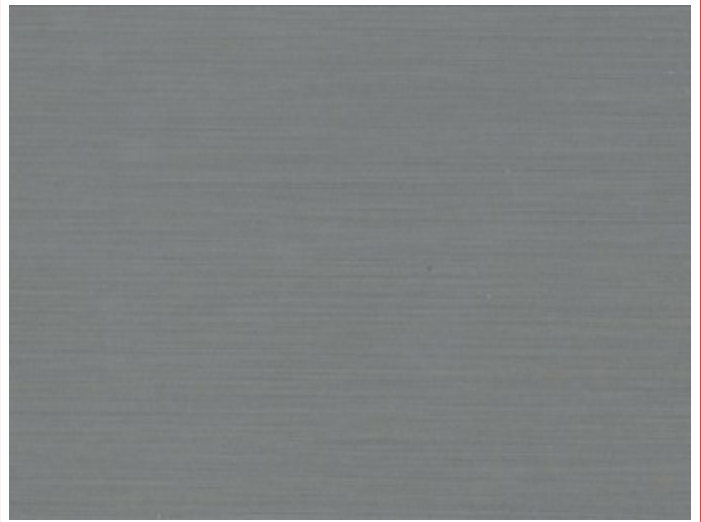

20) Alluminio Naturale

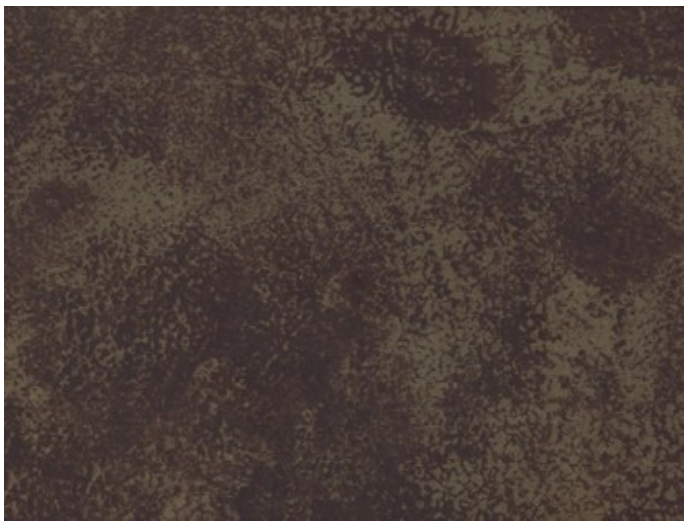

21) Ruggine Scura



22) Ruggine Marrone

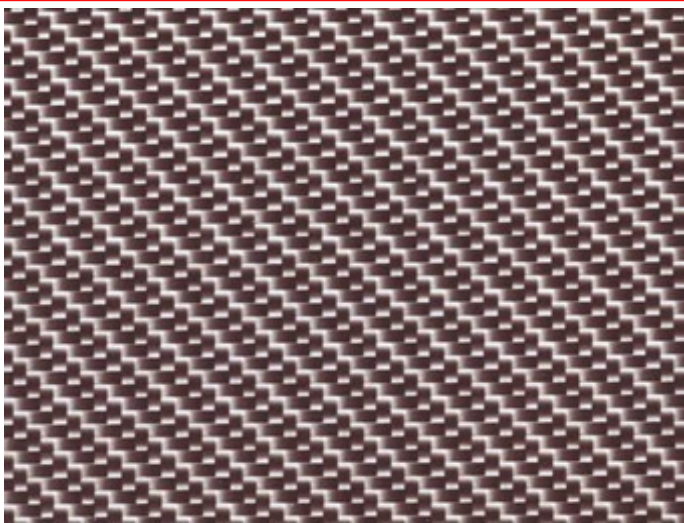

23) Carbonio Chiaro



24) Acciaio Chiaro



25) Verderame 2

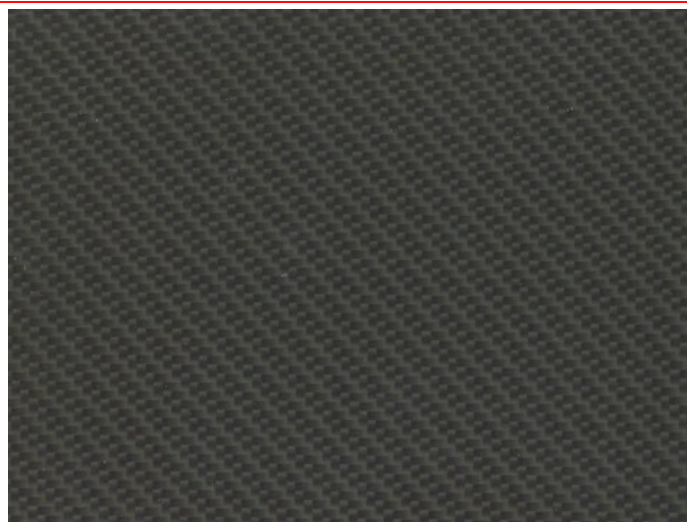

26) Carbonio Scuro

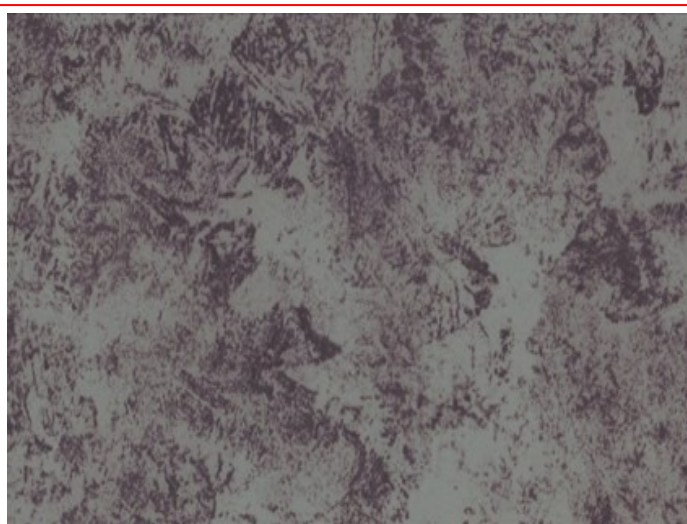

27) Alluminio Scuro



28) Alluminio Chiaro

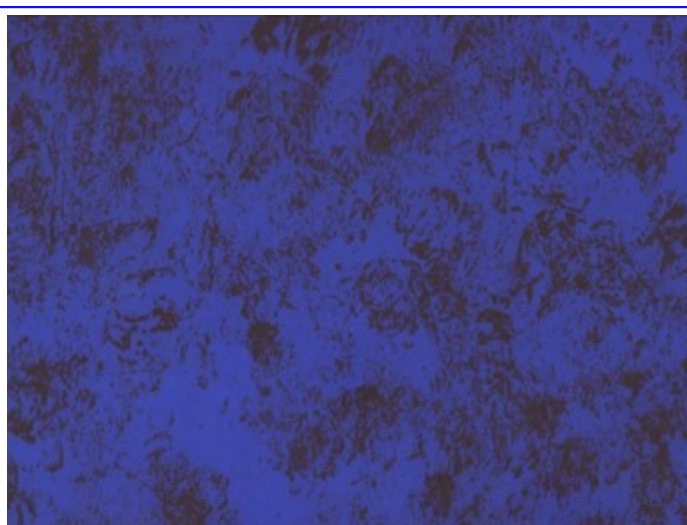

29) Marmo Maculato Blu

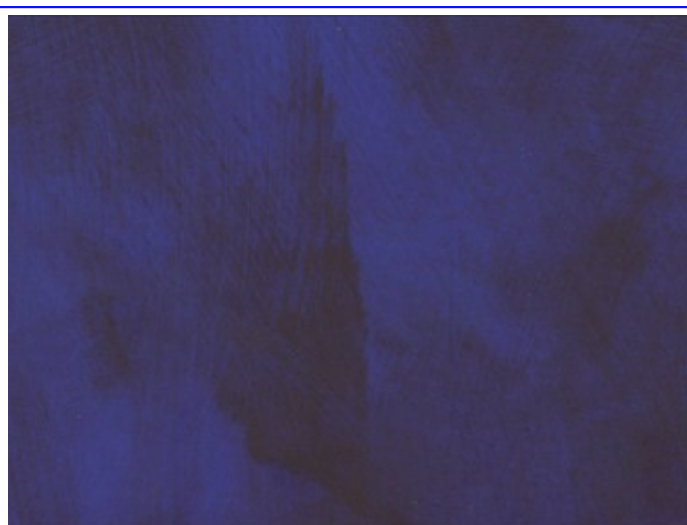

30) Spatolato Blu 2

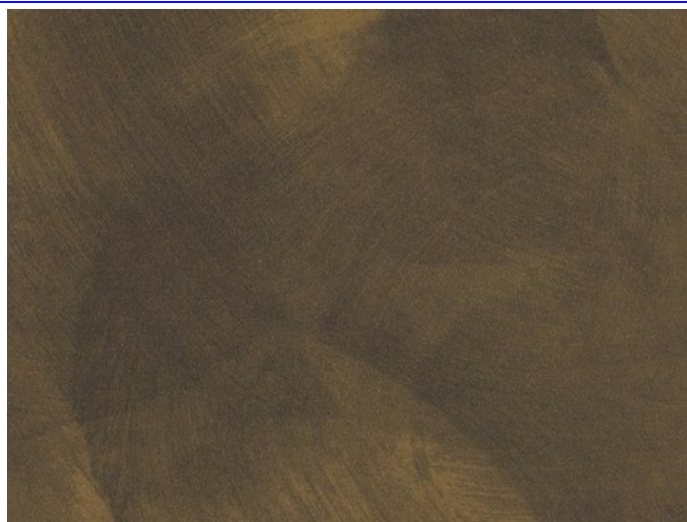

31) Spatolato



32) Spatolato Scuro



33) Spatolato Rosso

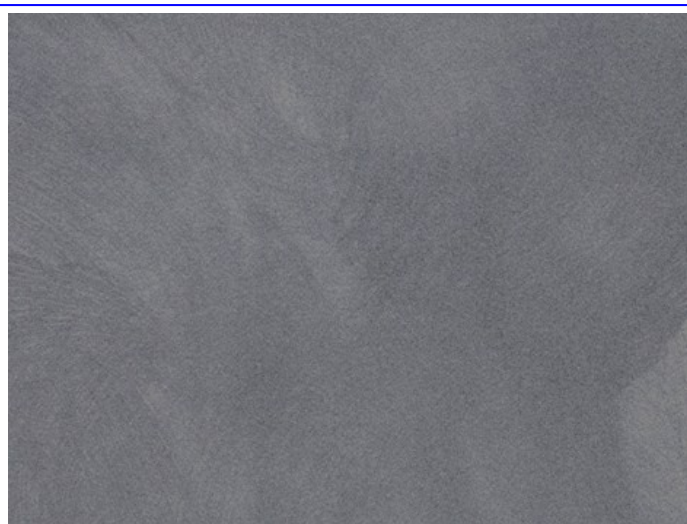

34) Spatolato Grigio

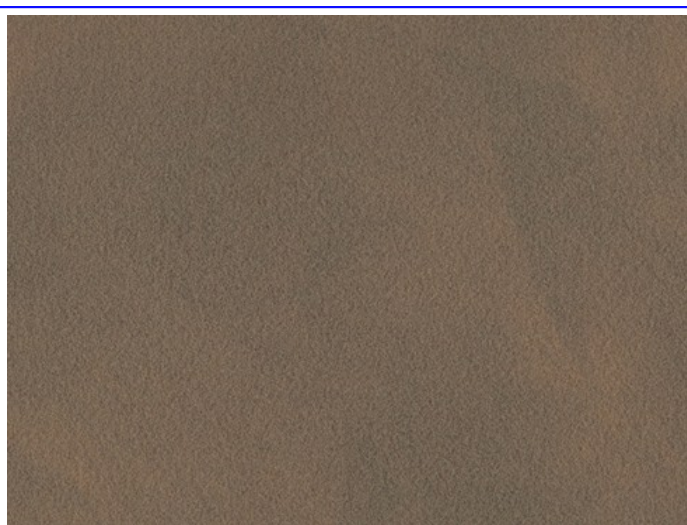

35) Spatolato Sabbia

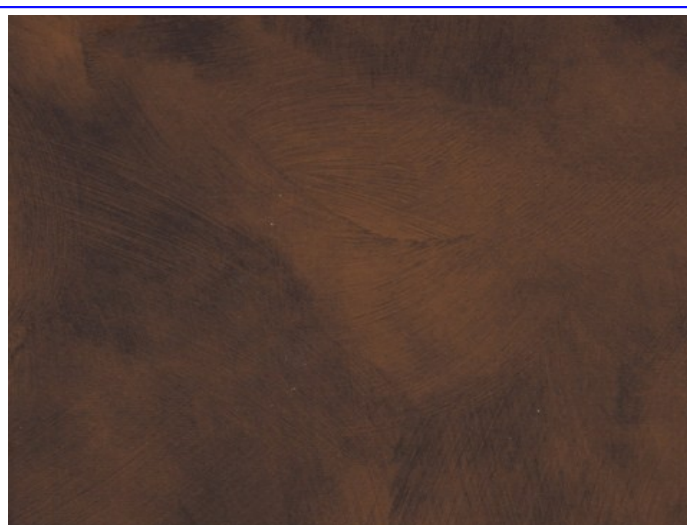

36) Spatolato Marrone



37) Spatolato Bronzo

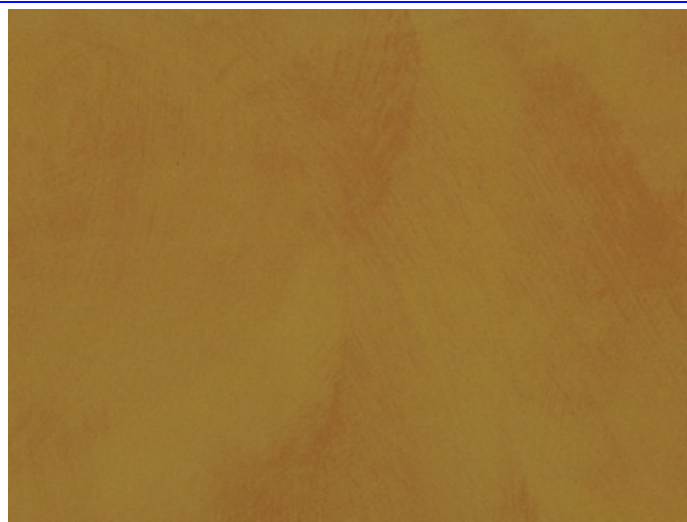

38) Spatolato Giallo

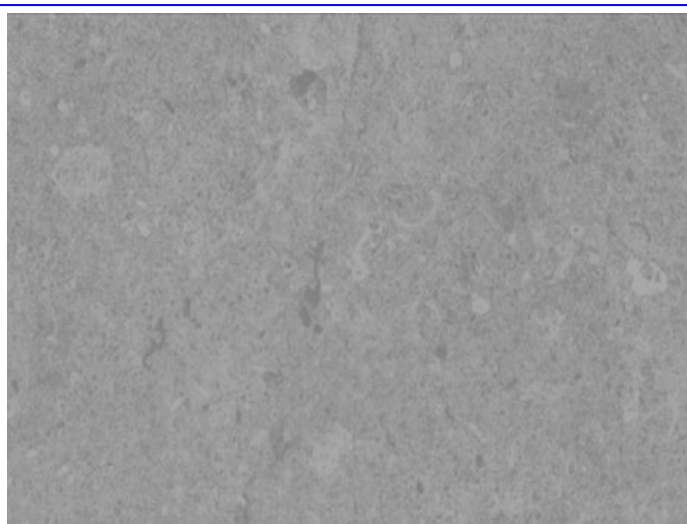

39) Marmo Chiaro



40) Marmo Scuro

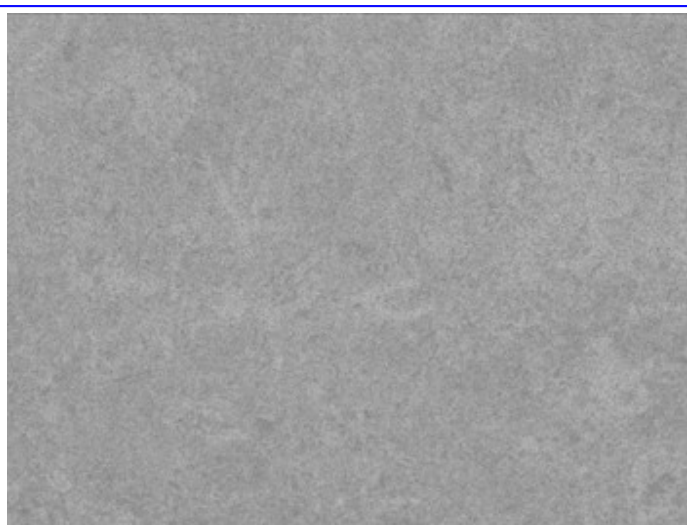

41) Marmo Argento



42) Marmo Verde

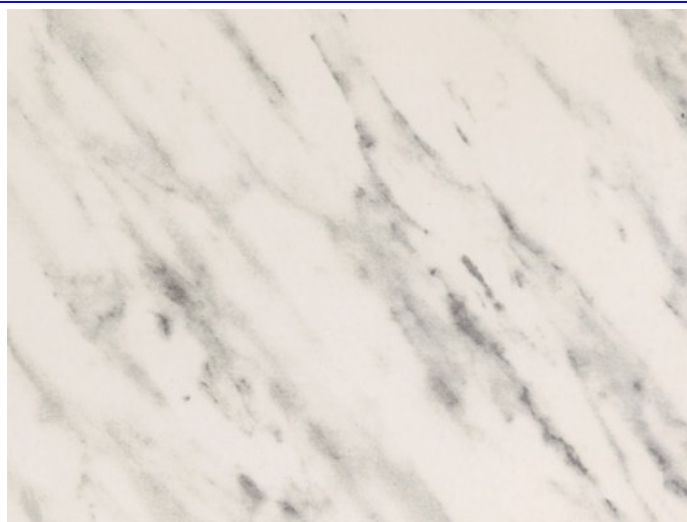

43) Marmo Nero

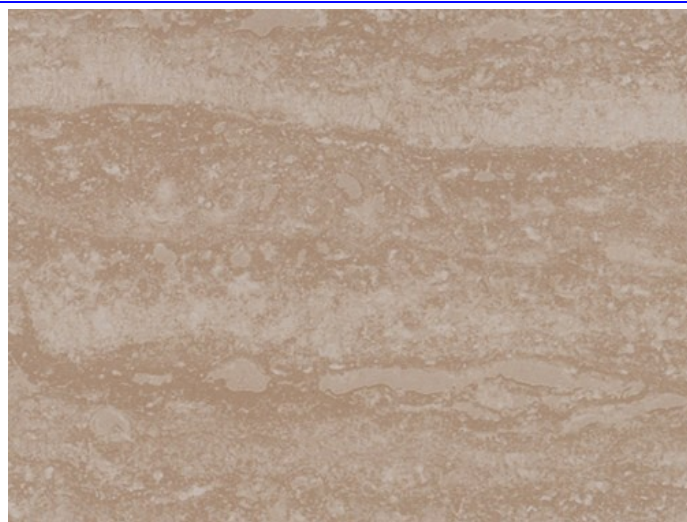

44) Marmo Rosa



45) Marmo Triste

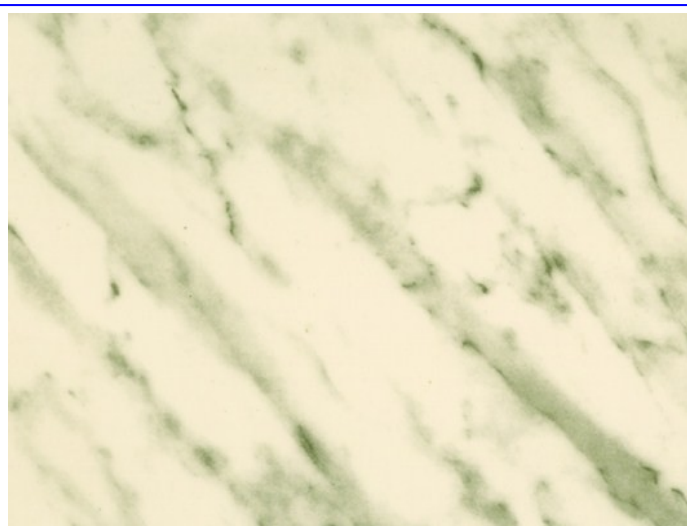

46) Marmo Verdino

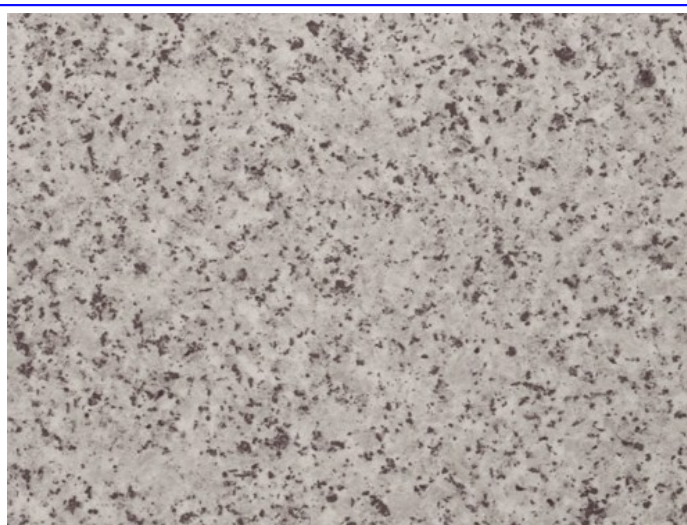

47) Granito Chiaro

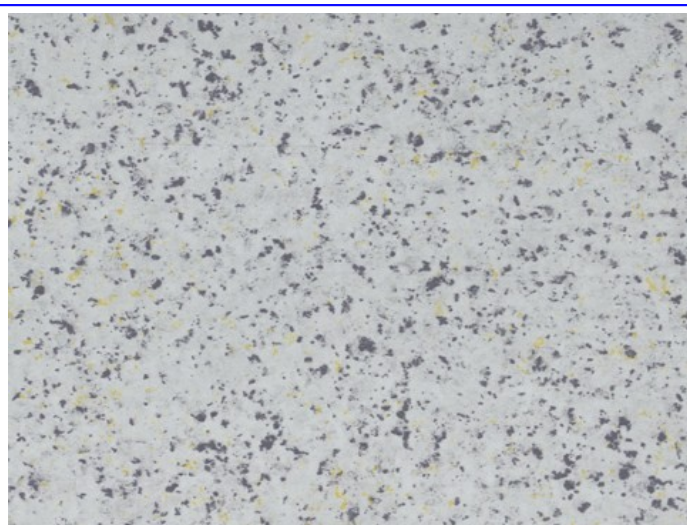

48) Granito Bianco



49) Granito Giallo



50) Marmo Fior di Pesco

È vietata la riproduzione, anche parziale, dei contenuti della presente cartella, senza il consenso scritto di Brunello Innovations Technology s.a.s.

Brunello Innovations Technology s.a.s.

Pradipaldo di Marostica (Vicenza), Via Fodati 1

E-mail: info@brunelloselementi.it - Tel: 0424 709095 - Fax: 0424 709389