

BOVELACCI



Dott. Ing. Bovelacci Marco 2009



CLASSICSTYL

- ① LE CORNICI IN POLIURETANO PER RIFINITURE D'INTERNI
- Ⓞ POLYURETHANE MOULDINGS FOR INTERIOR DECORATION
- ⓔ MOLDURAS EN POLIURETANO PARA LA DECORACIÓN DE INTERIORES
- Ⓟ SANCAS EM POLIURETANO PARA DECORAÇÃO DE INTERIORES



CLASSICSTYL

-  LE CORNICI IN POLIURETANO
-  POLYURETHANE MOULDINGS
-  ZIERPROFILE AUS POLYURETHAN
-  CORNICHES EN POLYURÉTHANE
-  MOLDURAS DECORATIVAS EN POLIURETANO
-  SANCAS EM POLIURETANO
-  SIERPROFIELEN UIT POLYURETHAAN
-  ΚΟΡΝΙΖΕΣ ΠΟΛΥΟΥΡΕΘΑΝΗΣ
-  POLYÜRETAN KARTONPIYER
-  POLYURETAN LISTER
-  STUKKATURLISTER I POLYURETHAN
-  STUKLISTER I POLYURETHAN
-  POLYURETANILISTAT
-  OKRASNE PROFILE IZ POLIURETAN
-  POLIURETAN PROFILI
-  ПЛИНТУСА ИЗ ПОЛИУРЕТАНА
-  GZYMSY Z POLIURETANU
-  POLIURETANOVÉ LIŠTY
-  CORNISE DIN POLIURETAN
-  POLYURITAN DÍSZLÉCEK
-  ПЛІНТУС ПОЛІУРЕТАНОВИЙ
-  ПОЛИУРИТАНОВИ ПРОФИЛИ
-  聚氨酯装饰
-  ポリウレタン製飾り縁

POLIURETANO
POLYURETHANE

BOVELACCI



①

**LE CORNICI
PER SOFFITTI**

Cornici in poliuretano
Lunghezza: 2 ml per asta;
per i modelli decorati:
2 ml per asta ~±2%
Per l'installazione utilizzare
Classic Coll e chiodini in acciaio
senza testa

②

**CEILINGS
MOULDINGS**

Polyurethane mouldings
Length: 2 lm (78 3/4");
decorated patterns:
2 lm (78 3/4") ~±2%
For installation use Classic Coll
and steel nails without head

③

**MOLDURAS
PARA TECHO**

Molduras de poliuretano
Longitud: 2 metros;
modelos decorados:
2 metros ~±2%
Para el montaje use Classic
Coll y clavos sin cabeza

④

**SANCAS
PARA TETOS**

Sancas em poliuretano
Comprimento: 2 ml por barra;
modelos decorados:
2 ml por barra ~±2%
Se necessário, utilize Classic
Coll e pregos sem cabeça

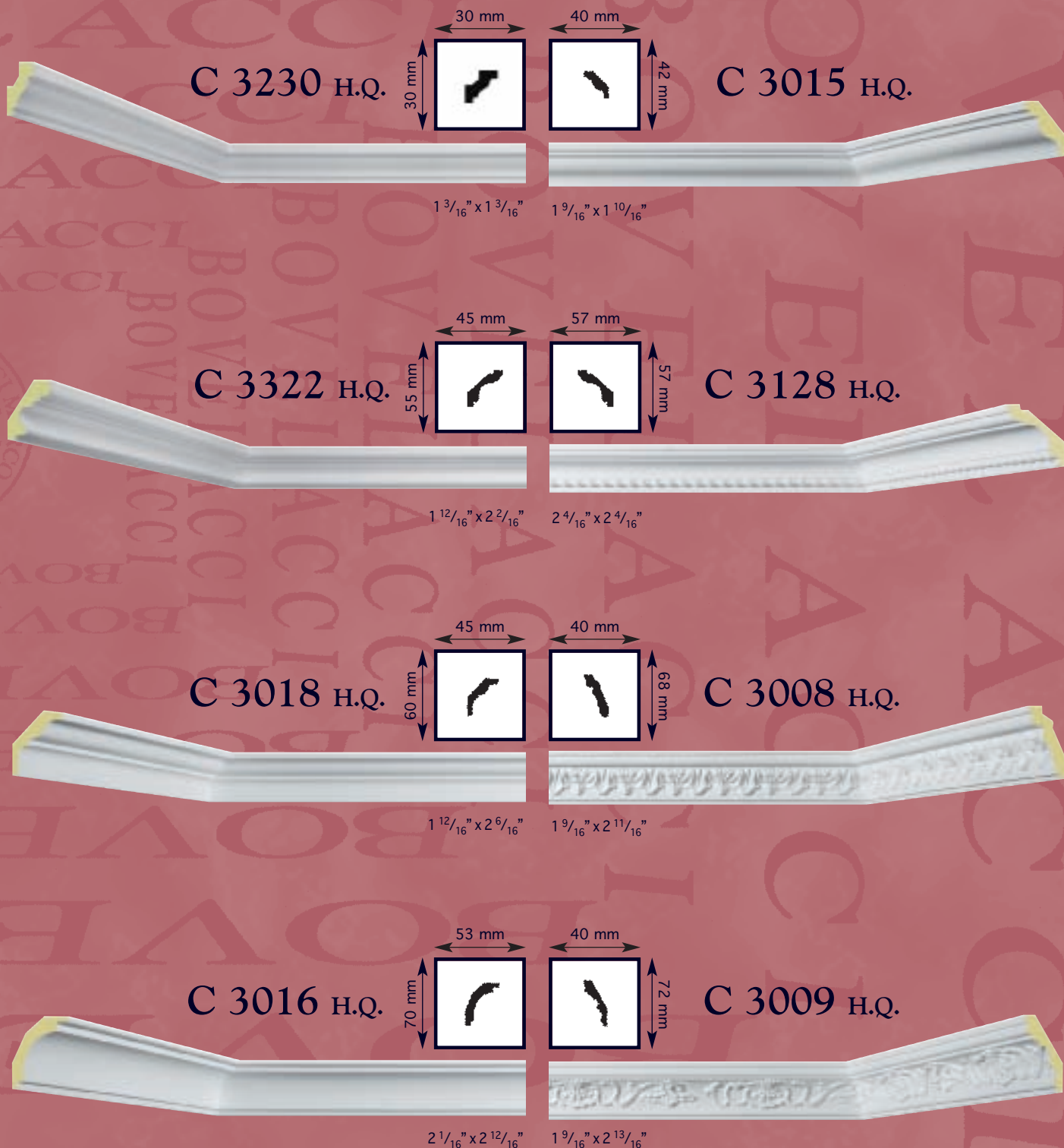

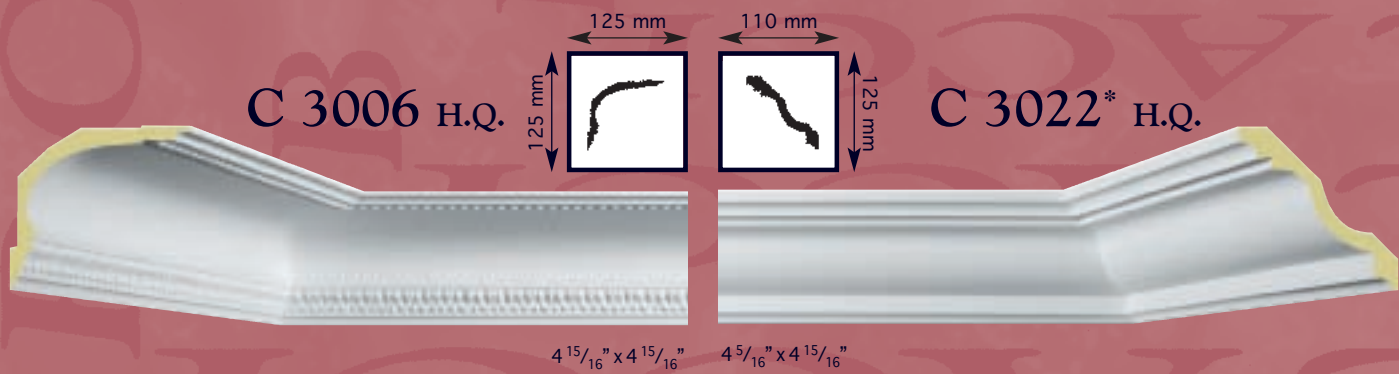
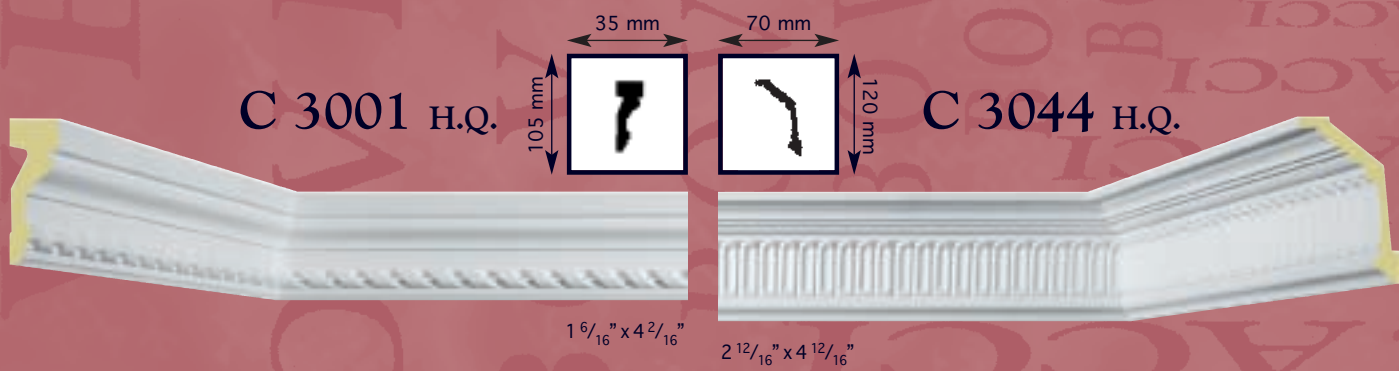
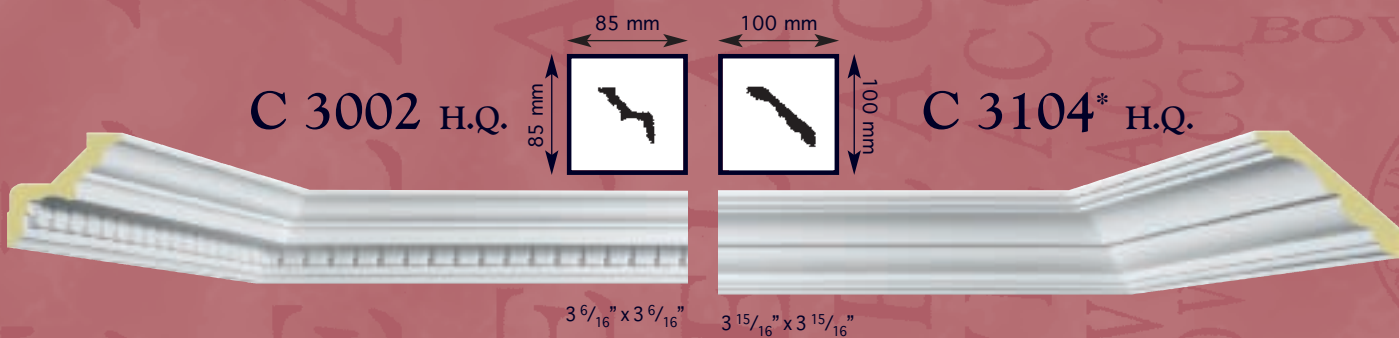
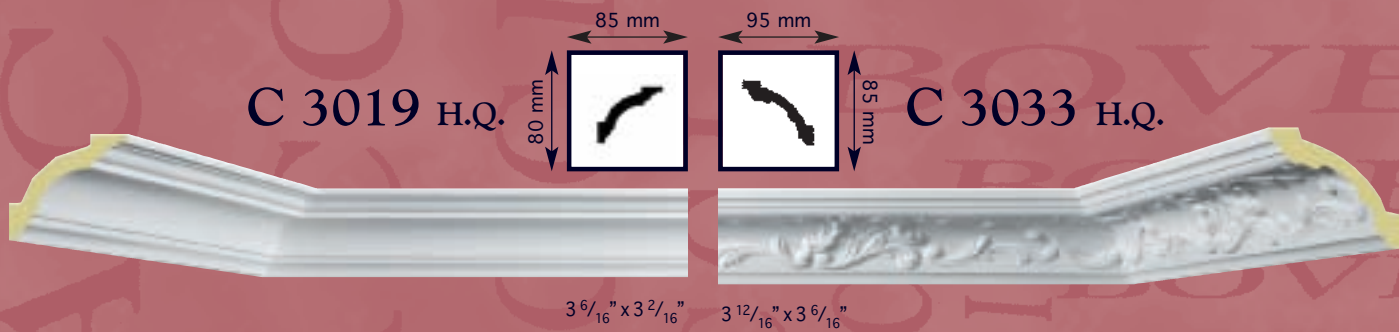
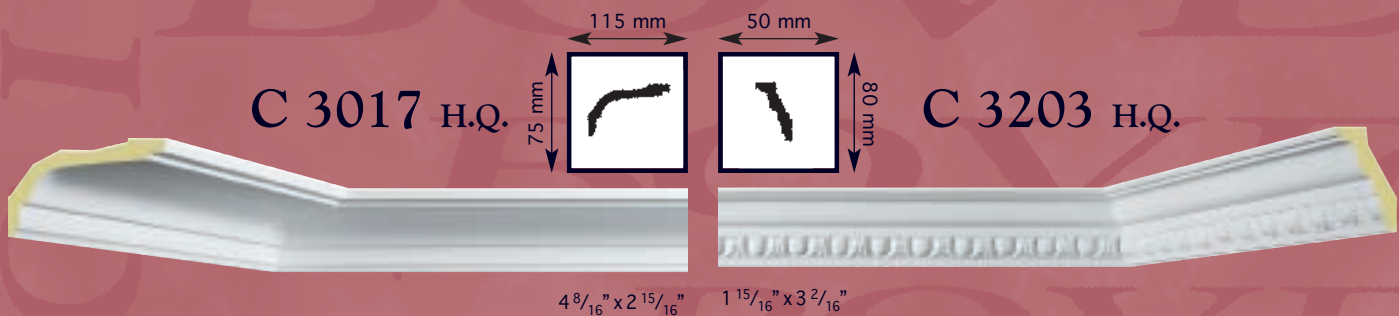

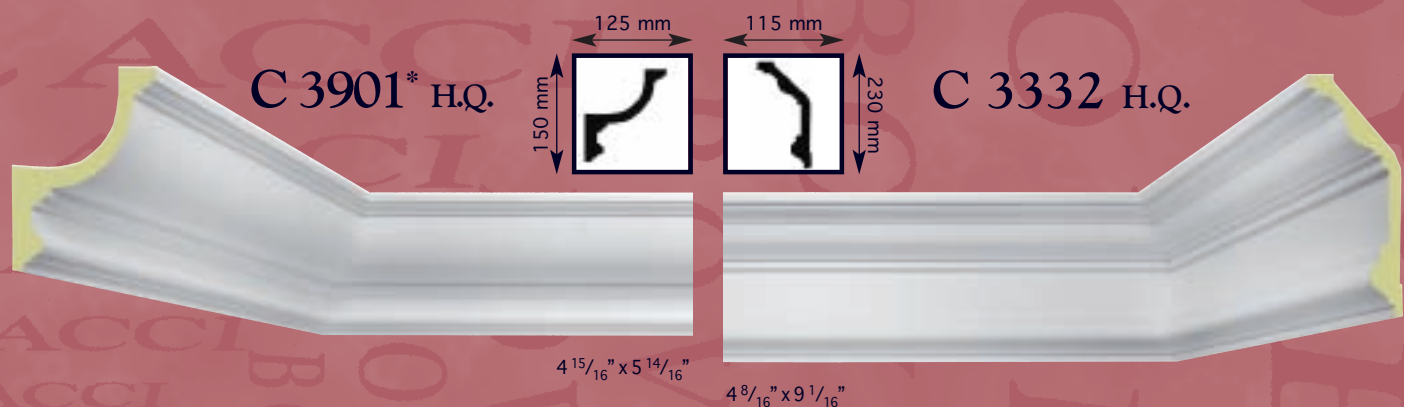
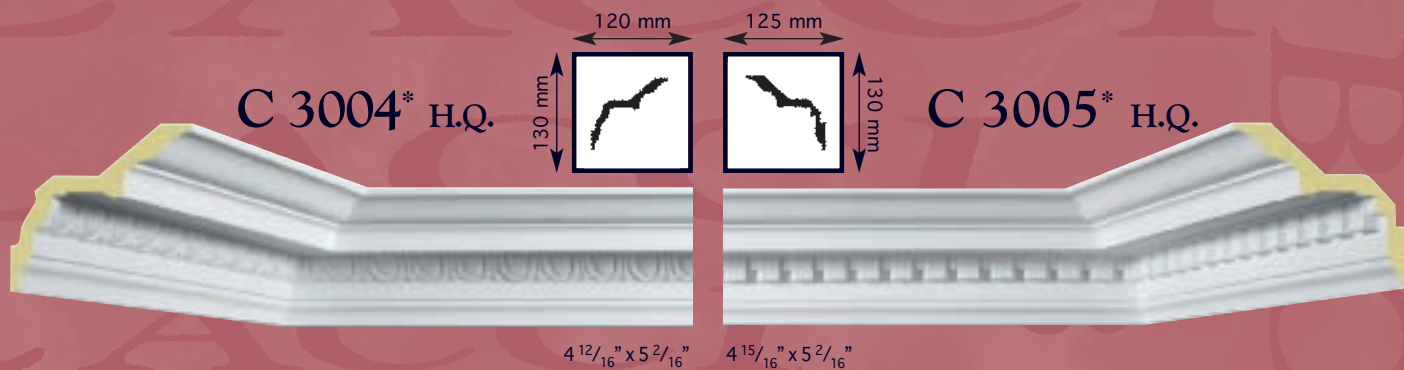

* Indicato anche per illuminazione indiretta
Temperatura d'impiego: -20° C ÷ +75° C

* Suitable also for indirect lighting
Temperature without deterioration: -20° C ÷ +75° C

* Apropriadas para la iluminación indirecta
Temperatura de empleo: -20° C ÷ +75° C

* Indicado para iluminação indireta
Temperatura sem deterioração: -20° C ÷ +75° C

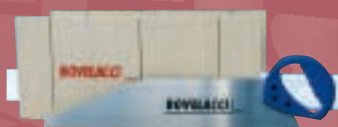

LA SEGA SPECIALE

L. 50 cm

LA CASSETTA PER TAGLIO

Dim. int. 16 x 20 x L. 50 cm

SPECIAL SAW

L. 50 cm

MITRE-BOX

Internal Dim. 16 x 20 x L. 50 cm

SIERRA ESPECIAL

L. 50 cm

CAJA PARA CORTES

Dim. int. 16 x 20 x L. 50 cm

SERRA ESPECIAL

L. 50 cm

CAIXA DE CORTE

Dim. int. 16 x 20 x C. 50 cm

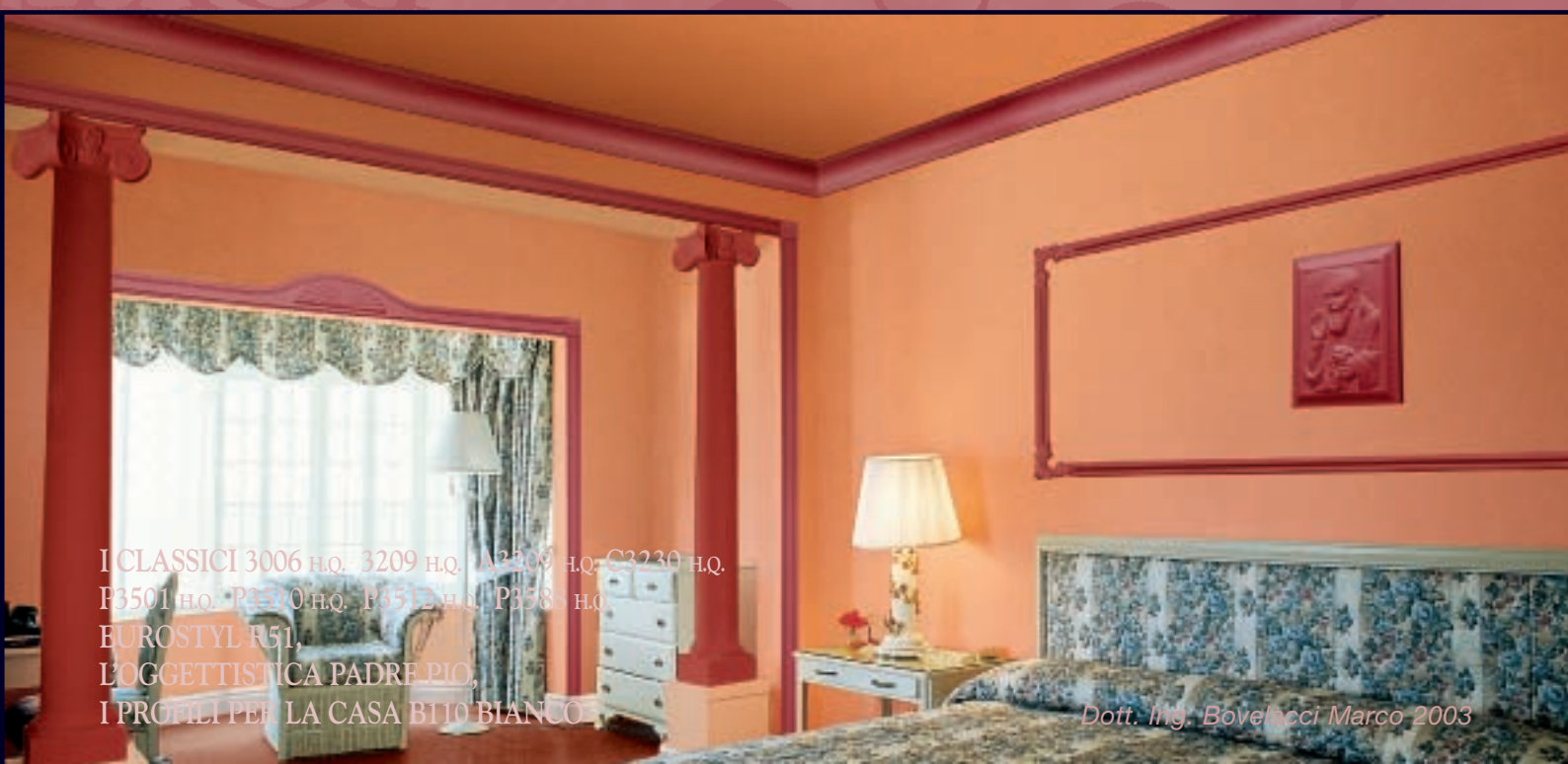

I CLASSICI 3006 H.Q. 3209 H.Q. A3209 H.Q. C3230 H.Q.
P3501 H.Q. P3510 H.Q. P3512 H.Q. P3588 H.Q.
EUROSTYL R51,
L'OGGETTISTICA PADRE PIO,
I PROFILI PER LA CASA BIIIO BIANCO



I

***LE CORNICI PER ILLUMINAZIONE INDIRETTA**

Lunghezza: 2 ml per asta
 Per l'istallazione usare Classic Coll, chiodini in acciaio senza testa e squadretti
 Temperatura d'impiego: -20° C ÷ +75° C



GB

***MOULDINGS FOR INDIRECT LIGHTING**

Length: 2 lm (78 3/4")
 For installation use Classic Coll, steel nails without head and brackets
 Temperature without deterioration: -20° C ÷ +75° C



E

***MOLDURAS PARA LA ILUMINACIÓN INDIRECTA**

Longitud: 2 metros
 Para el montaje use Classic Coll, clavos y soportes
 Temperatura de empleo: -20° C ÷ +75° C



P

***SANCAS PARA ILUMINAÇÃO INDIRETA**

Comprimento: 2 ml por barra
 Para a instalação usar Classic Coll, os pregos sem cabeça e suportes
 Temperatura sem deterioração: -20° C ÷ +75° C

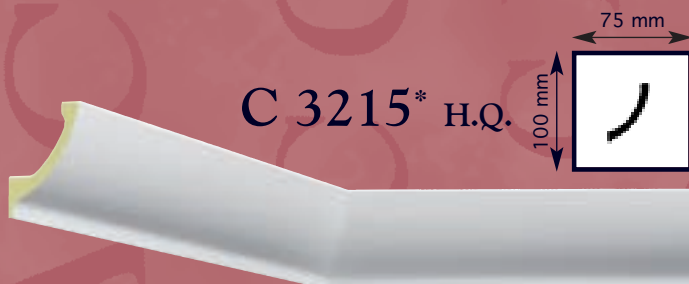

C 3215* H.Q.

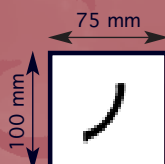

2 15/16" x 3 15/16"



C 3225* H.Q.

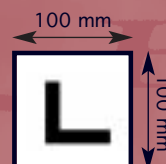

3 15/16" x 3 15/16"



C 3216* H.Q.

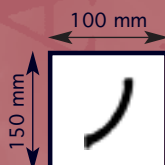

3 15/16" x 5 14/16"

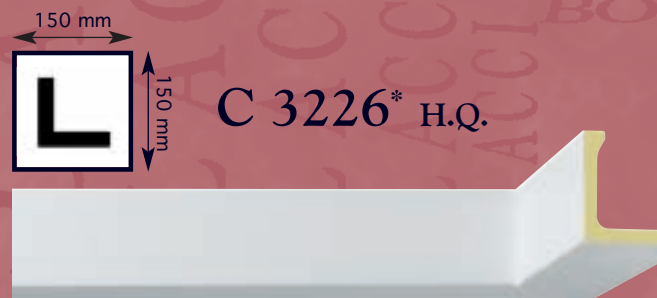

C 3226* H.Q.

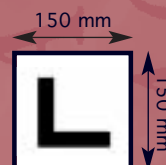

5 14/16" x 5 14/16"



C 3217* H.Q.

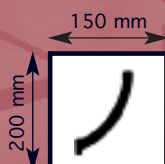

5 14/16" x 7 14/16"

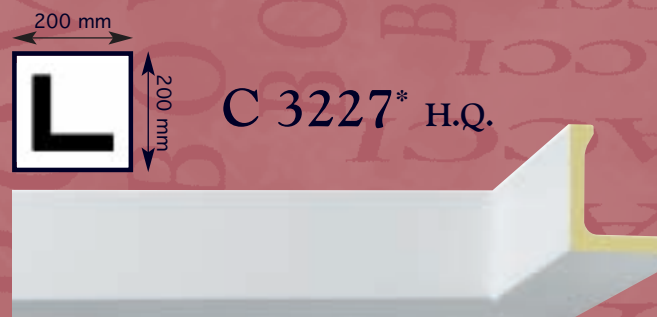

C 3227* H.Q.

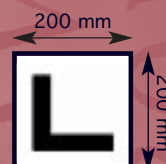

7 14/16" x 7 14/16"



C 3218* H.Q.



7 14/16" x 9 13/16"

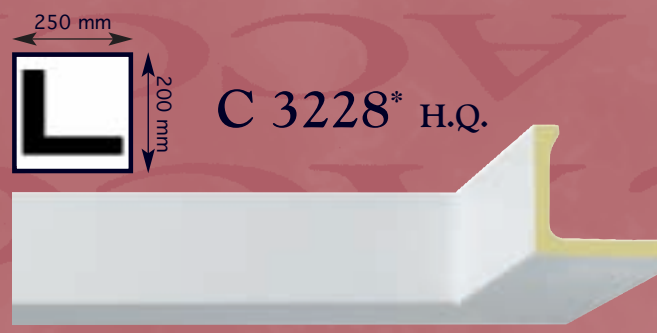

C 3228* H.Q.

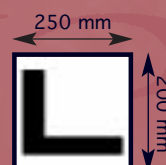

9 13/16" x 7 14/16"

①

LE CORNICI E GLI ANGOLI PER PARETI E SOFFITTI

Lunghezza: 2 ml per asta;
per i modelli decorati:
2 ml per asta ~±2%

②

PANEL MOULDINGS AND CORNERS

Length: 2 lm (78 3/4");
decorated patterns:
2 lm (78 3/4") ~±2%

③

MOLDURAS Y ÁNGULOS PARA PAREDES Y TECHOS

Longitud: 2 metros;
modelos decorados:
2 metros ~±2%

④

SANCAS E ÂNGULOS PARA PAREDES E TETOS

Comprimento: 2 ml por barra;
modelos decorados:
2 ml por barra ~±2%

C 3010 H.Q.



F3010 H.Q.
24 x 11 cm

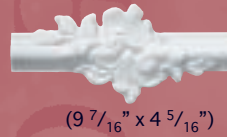

A3010 H.Q.
15 x 15 x r. 8 cm

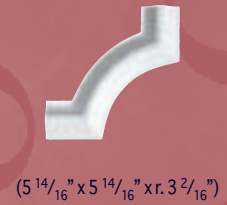

C 3209 H.Q.



A3209 H.Q.
14,5 x 14,5 cm

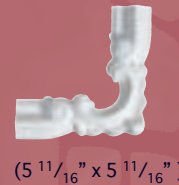

C 3120 H.Q.



A3120 H.Q.
25 x 25 x r. 14 cm



C 3060 H.Q.



C 3040 H.Q.



C 3430 H.Q.



C P3510 H.Q.



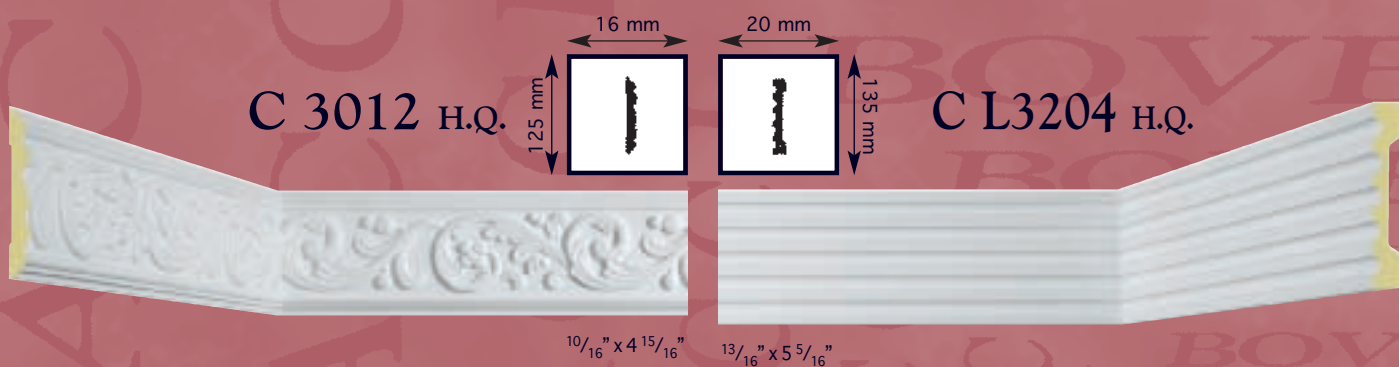
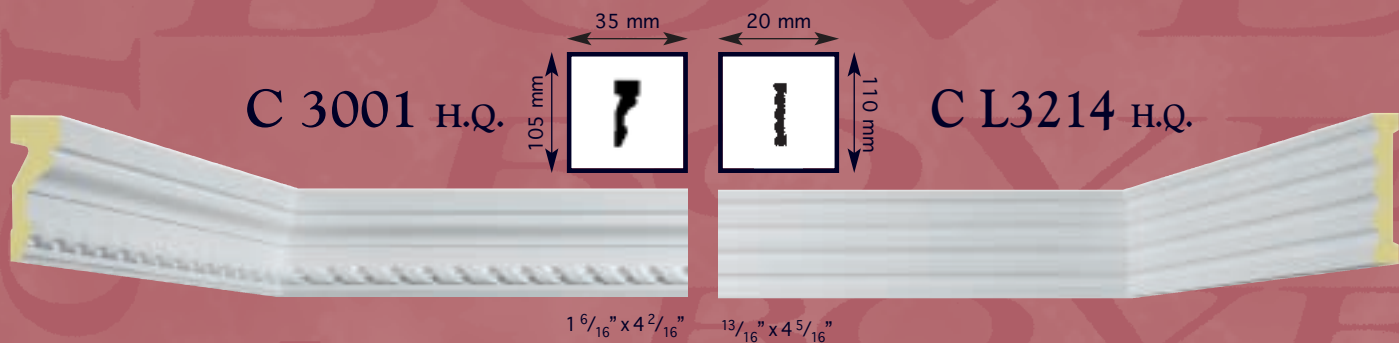

Per l'installazione utilizzare Classic Coll e chiodini in acciaio senza testa

For installation use Classic Coll and steel nails without head

Para el montaje use Classic Coll y clavos

Se necessário, utilize Classic Coll e pregos sem cabeça



IL DISPLAY I CLASSICI



AMERICANSTYL A13W,
EUROSTYL C00, P5L,
CLASSICSTYL A3010 H.Q. 3010 H.Q.
ITALSTYL A745L, 745

I

CLASSICSTYL FLEX

Le cornici in poliuretano flessibile
 Lunghezza: 2 ml per asta

GB

CLASSICSTYL FLEX

Flexible polyurethane mouldings
 Length: 2 lm (78 3/4")

E

CLASSICSTYL FLEX

Molduras de poliuretano flexible
 Longitud: 2 metros

P

CLASSICSTYL FLEX

Molduras de poliuretano flexíveis
 Comprimento: 2 ml por barra

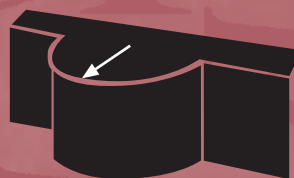
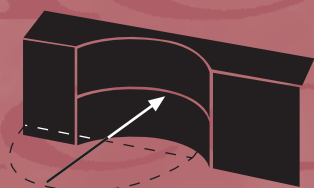

**CORNICI PER SOFFITTI
 CEILINGS MOULDINGS**

	dim = mm	r. curvatura = cm*
C 3001 FX	105x35	120
C 3010 FX	42x18	40
C 3012 FX	125x16	50
C 3040 FX	80x30	55
C 3060 FX	72x22	90
C 3120 FX	52x25	80
C 3209 FX	43x20	40
C 3430 FX	82x27	50
CL3204 FX	135x20	100
CL3214 FX	110x20	100
CP3510 FX	95x34	100

**CORNICI PER SOFFITTI
 PANEL MOULDINGS**

	dim = mm	r. curvatura = cm*
C 3009 FX	40x72	150
C 3015 FX	40x42	150
C 3016 FX	53x70	150
C 3018 FX	45x60	150
C 3019 FX	85x80	200
C 3022 FX	110x125	250
C 3128 FX	57x57	200
C 3203 FX	50x80	150
C 3230 FX	30x30	150
C 3322 FX	45x55	150



Dott. Ing. Bovelacci Marco 2008

* Raggio minimo di curvatura per rivestire colonne e/o pareti curve. Utilizzo: flettere a temperatura ambiente di circa +25° C

* Minimum radius of curvature applied to columns and / or curved walls. Flex at room temperature approx +/- 25 °C

* Radio mínimo de curvatura para revestir columnas o paredes curvas. Modo de empleo: doblar a una temperatura aproximativa de +/- 25° C

* Raio mínimo de curvatura para revestir colunas e ou paredes curvas. Exemplo: reter a temperatura ambiente acerca de + / - 25° C

(I)

I ROSONI

Per l'installazione utilizzare Classic Coll e chiodini in acciaio senza testa

(GB)

CEILING CENTRES

For installation use Classic Coll and steel nails without head

(E)

ROSETONES

Para el montaje use Classic Coll y clavos sin cabeza

(P)

ROSETAS PARA TETO

Se necessário, utilize Classic Coll e pregos sem cabeça



C R3321 H.Q.

ø 16,5 cm
(6 8/16")



C R3314 H.Q.

ø 33,5 cm
(13 3/16")



C R3305 H.Q.

ø 40 cm
(15 12/16")



C R3307 H.Q.

ø 43,5 cm
(17 2/16")



C R3323 H.Q.

ø 46 cm
(18 2/16")



C R3325 H.Q.

43,5x30,5 cm
(17 2/16" x 12")



C R3316 H.Q.

ø 48 cm
(19")



C R3308 H.Q.

ø 49,5 cm
(19 8/16")



C R3315 H.Q.

ø 57,5 cm
(22 9/16")



C R3311 H.Q.

ø 66,5 cm
(26 4/16")



C R3320 H.Q.

ø 76 cm
(29 15/16")



C R3324 H.Q.

ø 77 cm
(30 5/16")



C R3312 H.Q.

ø 83 cm
(32 11/16")



C R3322 H.Q.

ø 77x53 cm
(30 ⁵/₁₆" x 20 ¹⁴/₁₆")



C R3364 H.Q.

ø 96 cm
(37 ¹³/₁₆")

LE NICCHIE, LE

MENSOLE ED I FREGI

Per l'installazione utilizzare Classic Coll e chiodini in acciaio senza testa

NICHES, CORBELS AND DECORATIONS

For installation use Classic Coll and steel nails without head

NICHAS, MENSOLAS Y DECORACIONES

Para el montaje use Classic Coll y clavos

NICHOS, SUPORTES E ORNAMENTOS

Se necessário, utilize Classic Coll e pregos sem cabeça



C F3621 H.Q.

L. 14 x p. 2 x H. 8 cm
(L. 5 ⁸/₁₆" x d. 1 ¹³/₁₆" x H. 3 ²/₁₆")



C N3001 H.Q.

L. 45,5 x p. 20 x H. 77 cm
(L. 17 ¹⁵/₁₆" x d. 7 ¹¹/₁₆" x H. 30 ⁵/₁₆")



C N3002 H.Q.

L. 27,8 x p. 8 x H. 49 cm
(L. 11" x d. 3 ²/₁₆" x H. 19 ⁵/₁₆")



C F3654 H.Q.

L. 12,5 x p. 1 x H. 13 cm
(L. 4 ¹⁵/₁₆" x d. 6 ¹/₁₆" x H. 5 ²/₁₆")



C F3623 H.Q.

L. 11,7 x p. 2 x H. 16 cm
(L. 4 ¹⁰/₁₆" x d. 1 ¹³/₁₆" x H. 6 ⁵/₁₆")

C N3001 H.Q.

L. 45,5 x p. 20 x H. 77 cm
(L. 17 ¹⁵/₁₆" x d. 7 ¹¹/₁₆" x H. 30 ⁵/₁₆")

C N3002 H.Q.

L. 27,8 x p. 8 x H. 49 cm
(L. 11" x d. 3 ²/₁₆" x H. 19 ⁵/₁₆")

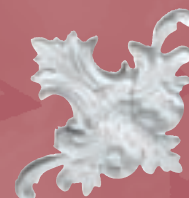

C F3652 H.Q.

L. 24 x p. 2 x H. 18 cm
(L. 9 ⁷/₁₆" x d. 1 ¹³/₁₆" x H. 7 ¹/₁₆")



C F3624 H.Q.

L. 16 x p. 4 x H. 26,5 cm
(L. 6 ⁵/₁₆" x d. 1 ⁹/₁₆" x H. 10 ⁷/₁₆")



C M3823 H.Q.

L. 10,5 x p. 7 x H. 14,5 cm
(L. 4 ²/₁₆" x d. 2 ¹²/₁₆" x H. 5 ¹¹/₁₆")



C M3403 H.Q.

L. 19 x p. 10 x H. 19 cm
(L. 7 ⁸/₁₆" x d. 3 ¹⁵/₁₆" x H. 7 ⁸/₁₆")



C M3962 H.Q.

L. 17,5 x p. 12,5 x H. 25,5 cm
(L. 6 ¹⁴/₁₆" x d. 4 ¹⁵/₁₆" x H. 10")

(I)

I DIFFUSORI APPLIQUE

Diffusori per illuminazione indiretta
Per l'installazione utilizzare Classic Coll e chiodini in acciaio senza testa
Temperatura d'impiego: -20° C ÷ +75° C

(GB)

WALL LIGHTINGS

Appliques for indirect lighting
For installation use Classic Coll and steel nails without head
Temperature without deterioration: -20° C ÷ +75° C

(E)

APLIQUES

Appliques de luz indirecta
Para el montaje use Classic Coll y clavos
Temperatura de empleo: -20° C ÷ +75° C

(P)

APLIQUES DE PAREDE

Appliques para iluminação indireta
Se necessário, utilize Classic Coll e pregos sem cabeça
Temperatura sem deterioração: -20° C ÷ +75° C



C D3704 H.Q.
L.30 x H.14 x p.12,5 cm
(L. 11 13/16" x d. 5 8/16" x H. 4 15/16")



C D3705 H.Q.
L.42 x H.12 x p.12 cm
(L. 16 9/16" x d. 4 12/16" x H. 4 12/16")



C D3709 H.Q.
L.35,5 x H.16,5 x p.14,5 cm
(L. 14" x d. 6 8/16" x H. 5 11/16")



C D3713 H.Q.
L.45,5 x H.20,5 x p. 20,5 cm
(L. 17 15/16" x d. 8 1/16" x H. 8 1/16")

(I)

LE LESENE

Non portanti; componibili

(GB)

PILASTERS

Not supporting; modular

(E)

PILARES

No soportan peso; armables

(P)

LESENAS

Não portante; Intermutável

C L3211 H.Q.
L. 17,5 x p. 4,5 - H. 16 cm
(L. 6 14/16" x d. 1 12/16" - H. 6 5/16")



C L3201 H.Q.
L. 21,5 x p. 5,5 - H. 13 cm
(L. 8 7/16" x d. 2 3/16" - H. 5 2/16")



C L3205P H.Q.
L. 28,5 x p. 9,5 - H. 20 cm
(L. 11 5/16" x d. 3 12/16" - H. 7 14/16")



C L3205G
L. 28,5 x p. 9,5 - H. 18 cm
(L. 11 5/16" x d. 3 12/16" - H. 7 1/16")



C L3206 H.Q.
L. 46 x p. 7,5 - H. 18 cm
(L. 18 2/16" x d. 2 15/16" - H. 7 1/16")



C L3206 H.Q.
L. 46 x p. 7,5 - H. 18 cm
(L. 18 2/16" x p. 2 15/16" - H. 7 1/16")



C L3206RP H.Q.
L. 25,7 x p. 3,7 - H. 12,3 cm
(L. 10 2/16" x d. 1 7/16" - H. 4 13/16")



C L3206RG H.Q.
L. 25,7 x p. 3,7 - H. 10,3 cm
(L. 10 2/16" x p. 1 7/16" - H. 4 1/16")



C L3213 H.Q.
L. 11 x p. 3 - H. 26 cm
(L. 4 5/16" x d. 1 3/16" - H. 10 4/16")



C L3212 H.Q.
L. 11 x p. 2 - H. 205 cm
(L. 4 5/16" x d. 13/16" - H. 80 12/16")



C L3202 H.Q.
L. 13,5 x p. 2 - H. 206 cm
(L. 5 5/16" x d. 13/16" - H. 81 2/16")



C L3203 H.Q.
L. 13,5 x p. 3 - H. 26 cm
(L. 5 5/16" x d. 1 3/16" - H. 10 4/16")



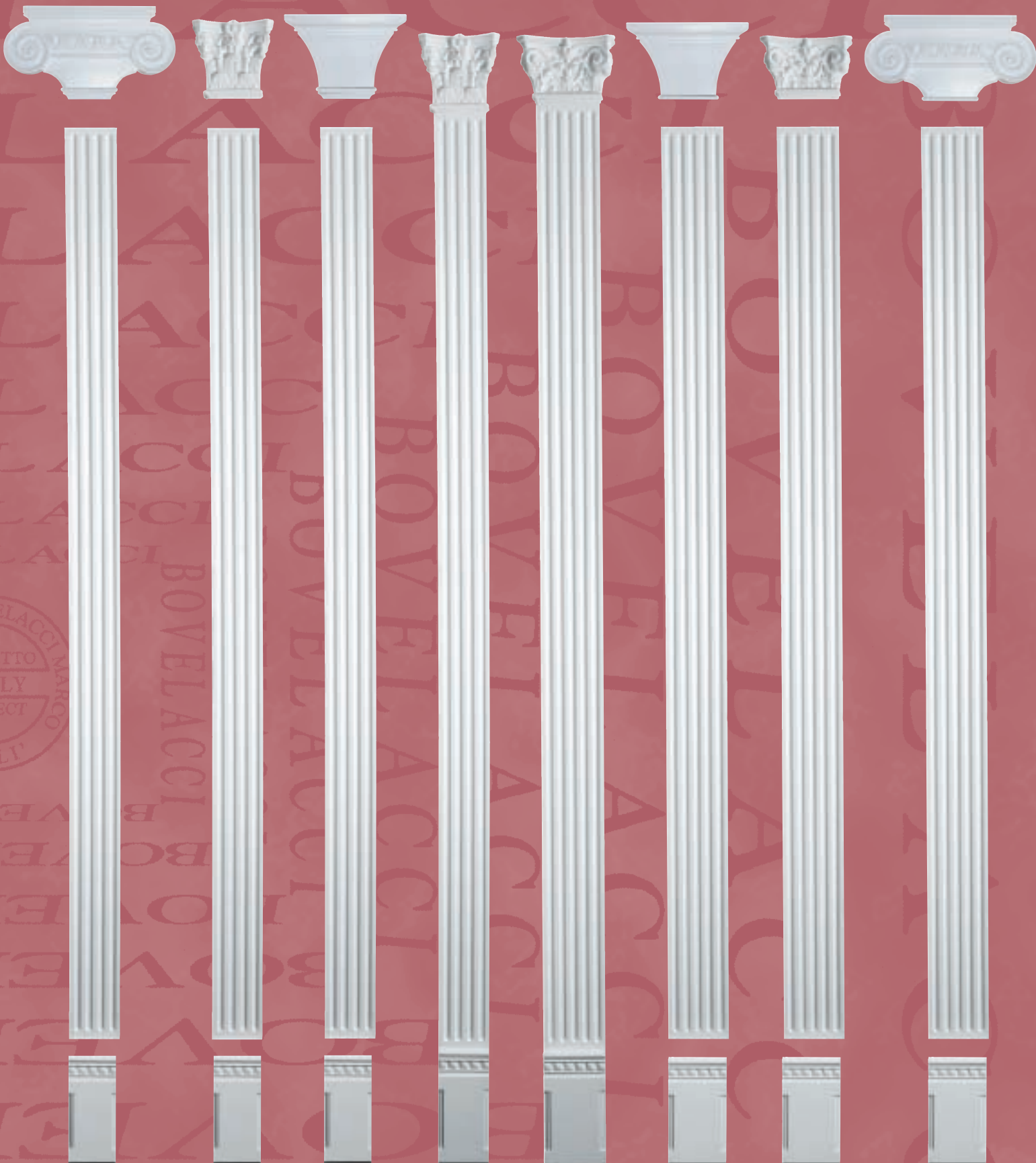

C L3206 H.Q.
+
C L3206RP H.Q.
+
C L3212 H.Q.
+
C L3213 H.Q.
H. 256 cm
(100 ¹³/₁₆")

C L3211 H.Q.
+
C L3212 H.Q.
+
C L3213 H.Q.
H. 247 cm
(97 ⁴/₁₆")

C L3205P H.Q.
+
C L3212 H.Q.
+
C L3213 H.Q.
H. 251 cm
(98 ¹³/₁₆")

C L3211 H.Q.
LESENA PICCOLA
H. 248 cm
(97 ¹⁰/₁₆")

C L3200 H.Q.
LESENA GRANDE
H. 246 cm
(96 ¹⁴/₁₆")

C L3205G H.Q.
+
C L3202 H.Q.
+
C L3203 H.Q.
H. 249 cm
(98 ¹/₁₆")

C L3201 H.Q.
+
C L3202 H.Q.
+
C L3203 H.Q.
H. 245 cm
(96 ⁸/₁₆")

C L3206 H.Q.
+
C L3206RG H.Q.
+
C L3202 H.Q.
+
C L3203 H.Q.
H. 254 cm
(100")

(I)

**LE DECORAZIONI
PER LE PORTE**

Per l'installazione utilizzare Classic Coll
e chiodini in acciaio senza testa

(GB)

**DOORS
SURROUNDS**

For installation use Classic Coll
and steel nails without head

(E)

**DECORACIONES
PARA PUERTAS**

Para el montaje use Classic
Coll y clavos sin cabeza

(P)

**DECORAÇÕES
PARA PORTAS**

Se necessário, utilize Classic
Coll e pregos sem cabeça

P3588 H.Q.

9,5 x 9,5 x p. 5 cm
(13 12/16" x 13 12/16" x d. 2")

P3501 H.Q.

L. 125 x p. 3,4 x H. 19,5 cm (L 49 3/16" x d. 1 5/16" - H. 7 11/16")



P3510 H.Q.



H. 200 cm
(78 12/16")

P3562 H.Q.

L. 15,4 x p. 1,6 x H. 11,5 cm
(L 6 1/16" x d. 10/16" - H. 4 8/16")

P3515 H.Q.

L. 23,5 x p. 3 x H. 13 cm
(L 9 4/16" x d. 1 3/16" - H. 5 2/16")

P3511 H.Q.

2 x (L. 31 x p. 1 x H. 10,8 cm)
2 x (L 12 3/16" x d. 6/16" - H. 4 4/16")

P3512 H.Q.

L. 43,5 x p. 1,6 x H. 11,5 cm
(L 17 2/16" x d. 10/16" - H. 4 8/16")

P3514 H.Q.

L. 32,5 x p. 1,6 x H. 13,5 cm
(L 12 13/16" x d. 10/16" - H. 5 5/16")

P3587 H.Q.

L 9,5 x p. 4 x H. 25,5 cm
(L 3 12/16" x d. 1 9/16" x H 10")

P3590 H.Q.

55 x 75,5 x p. 1,6 cm
(21 10/16" x 29 11/16" x d. 10/16")

P3591 H.Q.

55 x 22 x p. 1,6 cm
(21 10/16" x 8 11/16" x d. 10/16")

P3592 H.Q.

55 x 55 x p. 1,6 cm
(21 10/16" x 21 10/16" x d. 10/16")



①

LE BIBLIOTECHE

Per l'installazione utilizzare Classic Coll e chiodini in acciaio senza testa

ⒼⒷ

LIBRARY

For installation use Classic Coll and steel nails without head

Ⓔ

LIBRERÍA

Para el montaje use Classic Coll y clavos sin cabeza

Ⓟ

BIBLIOTECA

Se necessário, utilize Classic Coll e pregos sem cabeça

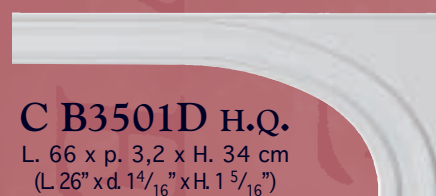
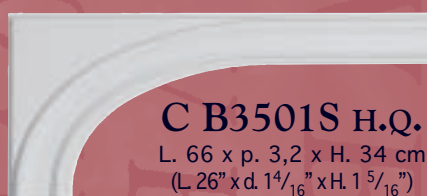

C B3501S H.Q.

L. 66 x p. 3,2 x H. 34 cm
(L. 26" x d. 1⁴/₁₆" x H. 1⁵/₁₆")

C B3501D H.Q.

L. 66 x p. 3,2 x H. 34 cm
(L. 26" x d. 1⁴/₁₆" x H. 1⁵/₁₆")

C P3585 H.Q.

L. 22,5 x p. 4,8 x H. 5 cm
(L. 8¹¹/₁₆" x d. 1¹⁴/₁₆" x H. 1¹⁵/₁₆")

C P3586 H.Q.

L. 12,5 x p. 4,8 x H. 5 cm
(L. 4¹⁵/₁₆" x d. 1¹⁴/₁₆" x H. 1¹⁵/₁₆")

C P3502 H.Q.

L. 9 x p. 4,5 x H. 11,5 cm
(L. 3⁹/₁₆" x d. 1¹²/₁₆" x H. 4⁸/₁₆")

P3510 H.Q.



H. 200 cm
(78¹²/₁₆")



P3587 H.Q.

L. 9,5 x p. 4 x H. 25,5 cm
(L. 3¹²/₁₆" x d. 1⁹/₁₆" x H. 10")

I
**LE COLONNE:
GLI ELEMENTI**

Componibili; non portanti

GB
**COLUMNS:
ELEMENTS**

Modular; not supporting

E
**COLUMNAS
ELEMENTOS**

Apilable; no soportan peso

P
**COLUNAS
ELEMENTOS**

Intermutável; não portante



C C3221 H.Q.
Capitello corinzio
35 x 35 x h. 30 cm
Corinthian capital
(13 12/16" x 13 12/16" x h. 11 13/16")

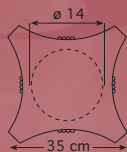

C C3231 H.Q.
Capitello ionico
35 x 35 x h. 14 cm
Ionic capital
13" x 13" x h. 5 2/16"



C C3241 H.Q.
Capitello dorico
37 x 37 x h. 30 cm
Doric capital
14 9/16" x 14 9/16" x h. 11 13/16"

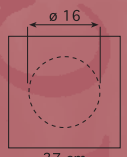

C C3223 H.Q.
Base
Ø 35x35 - h. 24 cm
Base big pilaster
(Ø 13 12/16" x 13 12/16" - h. 9 7/16")

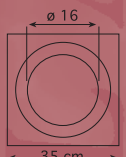

I
**LE MEZZE COLONNE:
GLI ELEMENTI**

Componibili; non portanti

GB
**HALF COLUMNS:
ELEMENTS**

Modular; not supporting

E
**MEDIAS COLUMNAS
ELEMENTOS**

No soportan peso; armables

P
**MEIAS COLUNAS
ELEMENTOS**

Não portante; Intermutável



C C3224 H.Q.
Mezzo capitello corinzio
35 x 17,5 x h. 30 cm
Half corinthian capital
(13 12/16" x 6 14/16" x h. 11 13/16")

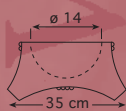

C C3234 H.Q.
Mezzo capitello ionico
35 x 17,5 x h. 14 cm
Half ionic capital
13" x 13" x h. 5 2/16"

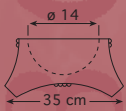

C C3244 H.Q.
Mezzo capitello dorico
37 x 18,5 x h. 30 cm
Half doric capital
14 9/16" x 14 9/16" x h. 11 13/16"

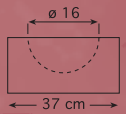

C C3226 H.Q.
Mezza base
35 x 17,5 x h. 24 cm
Half doric capital
14 9/16" x 14 9/16" x h. 11 13/16"

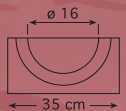

C C3222 H.Q.
Tronco rigato
Ø 22,5 - h. 204 cm
Fluted pillar
(Ø 8 14/16" - h. 80 5/16")



C C3232 H.Q.
Tronco liscio
Ø 22,5 - h. 204 cm
Smoothed pillar
(Ø 8 14/16" - h. 80 5/16")



C C3122 H.Q.
Tronchetto rigato
Ø 22,5 - h. 30 cm
Small Fluted pillar
(Ø 8 14/16" - h. 80 5/16")

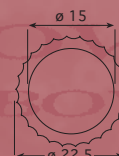

C C3132 H.Q.
Tronchetto liscio
Ø 22,5 - h. 30 cm
Small Smoothed pillar
(Ø 8 14/16" - h. 80 5/16")

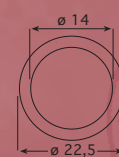

C C3225 H.Q.
Mezzo tronco rigato
Ø 22,5 x 11,3 x h. 204 cm
Half corinthian capital
(13 12/16" x 6 14/16" x h. 11 13/16")



C C3233 H.Q.
Mezzo tronco liscio
Ø 22,5 x 11,3 x h. 204 cm
Half ionic capital
13" x 13" x h. 5 2/16"

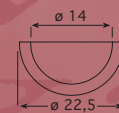

C C3133 H.Q.
Mezzo tronchetto rigato
Ø 22,5 x 11,3 x h. 30 cm
Half doric capital
14 9/16" x 14 9/16" x h. 11 13/16"



C C3123 H.Q.
Mezzo tronchetto liscio
Ø 22,5 x 11,3 x h. 30 cm
Half doric capital
14 9/16" x 14 9/16" x h. 11 13/16"

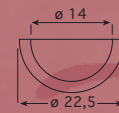

①

**LE COLONNE:
LE COMBINAZIONI**
Componibili; non portanti

②

**COLUMNS:
COMBINATIONS**
Modular; not supporting

③

**COLUMNAS
COMBINACIONES**
Apilable; no soportan peso

④

**COLUNAS
COMBINAÇÕES**
Intermutável; não portante



C C3220 H.Q.
COL. CORINZIA RIGATA
H. 255 cm (100 6/16")



C C3230 H.Q.
COL. IONICA LISCIA
H. 240 cm (94 8/16")



C C3240 H.Q.
COL. DORICA LISCIA
H. 255 cm (100 6/16")



C C3261 H.Q.
Colonneta corinzia rigata
(C3221 PU HQ + C3122 PU HQ
+ C3223 PU HQ
H. 81 (31 14/16")



C C3260 H.Q.
Colonneta corinzia liscia
(C3221 PU HQ + C3132 PU HQ
+ C3223 PU HQ
H. 81 (31 14/16")



C C3271 H.Q.
Colonneta ionica rigata
(C3231 PU HQ + C3122 PU HQ
+ C3223 PU HQ
H. 65 (26")



C C3270 H.Q.
Colonneta ionica liscia
(C3231 PU HQ + C3132 PU HQ
+ C3223 PU HQ
H. 65 (26")



C C3251 H.Q.
Colonneta dorica rigata
(C3241 PU HQ + C3122 PU HQ
+ C3223 PU HQ
H. 81 (31 14/16")



C C3250 H.Q.
Colonneta dorica liscia
(C3241 PU HQ + C3132 PU HQ
+ C3223 PU HQ
H. 81 (31 14/16")



C C3221 H.Q.
+ C C3222 H.Q.
+ C C3223 H.Q.
H. 255 cm
(100 6/16")



C C3231 H.Q.
+ C C3222 H.Q.
+ C C3223 H.Q.
H. 240 cm
(94 8/16")



C C3241 H.Q.
+ C C3222 H.Q.
+ C C3223 H.Q.
H. 255 cm
(100 6/16")



C C3221 H.Q.
+ C C3232 H.Q.
+ C C3223 H.Q.
H. 255 cm
(100 6/16")



C C3231 H.Q.
+ C C3232 H.Q.
+ C C3223 H.Q.
H. 240 cm
(94 8/16")



C C3241 H.Q.
+ C C3232 H.Q.
+ C C3223 H.Q.
H. 255 cm
(100 6/16")

(I)

**LE MEZZE COLONNE:
LE COMBINAZIONI**

Componibili; non portanti



C C3224 H.Q.
+ C C3225 H.Q.
+ C C3226 H.Q.
H. 255 cm (100 6/16")

(GB)

**HALF COLUMNS:
COMBINATIONS**

Not supporting; modular



C C3234 H.Q.
+ C C3225 H.Q.
+ C C3226 H.Q.
H. 240 cm (94 8/16")

(E)

**MEDIAS COLUMNAS
COMBINACIONES**

No soportan peso; armables



C C3244 H.Q.
+ C C3225 H.Q.
+ C C3226 H.Q.
H. 255 cm (100 6/16")



C C3224 H.Q.
+ C C3233 H.Q.
+ C C3226 H.Q.
H. 255 cm (100 6/16")

(P)

**MEIAS COLUNAS
COMBINAÇÕES**

Não portante; Intermutável



C C3234 H.Q.
+ C C3233 H.Q.
+ C C3226 H.Q.
H. 240 cm (94 8/16")



C C3244 H.Q.
+ C C3233 H.Q.
+ C C3226 H.Q.
H. 255 cm (100 6/16")

(I)

**LE MEZZE COLONNETTE:
LE COMBINAZIONI**

Non portanti; componibili



C C3224 H.Q. + C C3133 H.Q.
+ C C3226 H.Q. H. 81 cm (31 14/16")

(GB)

**HALF SMALL COLUMNS:
COMBINATIONS**

Not supporting; modular



C C3234 H.Q. + C C3133 H.Q.
+ C C3226 H.Q. H. 65 cm (26")

(E)

**MEDIAS COLUMNETAS:
COMBINACIONES**

No soportan peso; armables



C C3244 H.Q. + C C3133 H.Q.
+ C C3226 H.Q. H. 81 cm (31 14/16")

(P)

**MEIAS COLUNAS PEQUENAS:
COMBINAÇÕES**

Não portante; intermutável



C C3224 H.Q. + C C3123 H.Q.
+ C C3226 H.Q. H. 81 cm (31 14/16")



C C3234 H.Q. + C C3123 H.Q.
+ C C3226 H.Q. H. 65 cm (26")



C3244 H.Q. + C3123 H.Q.
+ C3226 H.Q. H. 81 cm (31 14/16")

(I)

**LE COLONNE:
GLI ELEMENTI**

Componibili; non portanti

(GB)

**COLUMNS:
ELEMENTS**

Modular; not supporting

(E)

**COLUMNAS
ELEMENTOS**

Apilable; no soportan peso

(P)

**COLUNAS
ELEMENTOS**

Intermutável; não portante



C C3351 H.Q.
Capitello ellenico
54 x 47 x h. 17 cm
Hellenic capital
(21 ⁴/₁₆" x 18 ⁸/₁₆" x h. 4 ⁵/₁₆")

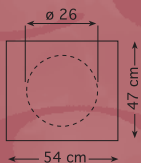

C C3331 H.Q.
Capitello ionico
50 x 50 x h. 19 cm
Ionic capital
19 ¹¹/₁₆" x 19 ¹¹/₁₆" x h. 7 ⁸/₁₆"

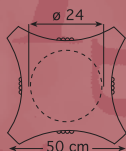

C C3323 H.Q.
Capitello dorico / Base
48,5 x 48,5 x h. 31 cm
Doric capital / Base
19 ²/₁₆" x 19 ²/₁₆" x h. 12 ³/₁₆"



(I)

**LE MEZZE COLONNE:
GLI ELEMENTI**

Non portanti; componibili

(GB)

**HALF COLUMNS:
ELEMENTS**

Not supporting

(E)

**MEDIAS COLUMNAS
ELEMENTOS**

No soportan peso; armables

(P)

**MEIAS COLUNAS
ELEMENTOS**

Não portante; Intermutável



C C3354 H.Q.
Mezzo capitello ellenico
54 x 23,5 x h. 17 cm
Half hellenic capital
(21 ⁴/₁₆" x 9 ⁴/₁₆" x h. 4 ⁵/₁₆")



C C3334 H.Q.
Mezzo capitello ionico
50 x 25 x h. 19 cm
Half ionic capital
(19 ¹¹/₁₆" x 9 ¹³/₁₆" x h. 7 ⁸/₁₆")

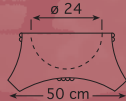

C C3326 H.Q.
Mezzo capitello dorico /
Mezza base
48,5 x 24,3 x h. 31 cm
Half doric capital
Half Base
19 ²/₁₆" x 9 ⁹/₁₆" x h. 12 ³/₁₆"



C C3322 H.Q.
Tronco rigato
Ø 30 - h. 305 cm
Fluted pillar
(Ø 11 ¹³/₁₆" - h. 120 ¹/₁₆")

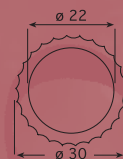

C C3332 H.Q.
Tronco liscio
Ø 30 - h. 305 cm
Smoothed pillar
(Ø 11 ¹³/₁₆" - h. 120 ¹/₁₆")



C C3622 H.Q.
Tronchetto rigato
Ø 30 - h. 30 cm
Small Fluted pillar
(Ø 11 ¹³/₁₆" - h. 11 ¹³/₁₆")



C C3632 H.Q.
Tronchetto liscio
Ø 30 - h. 30 cm
Small Smoothed pillar
(Ø 11 ¹³/₁₆" - h. 11 ¹³/₁₆")

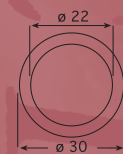

C C3325 H.Q.
Mezzo tronco rigato
Ø 30 x 15 x h. 305 cm
Half corinthian capital
(11 ¹³/₁₆" x 5 ¹⁴/₁₆" x h. 120 ¹/₁₆")



C C3333 H.Q.
Mezzo tronco liscio
Ø 30 x 15 x h. 305 cm
Half ionic capital
(11 ¹³/₁₆" x 5 ¹⁴/₁₆" x h. 120 ¹/₁₆")

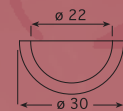

C C3633 H.Q.
Mezzo tronchetto rigato
Ø 30 x 15 x h. 30 cm
Half doric capital
11 ¹³/₁₆" x 5 ¹⁴/₁₆" x h. 11 ¹³/₁₆"

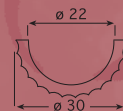

C C3623 H.Q.
Mezzo tronchetto liscio
Ø 30 x 15 x h. 30 cm
Half doric capital
11 ¹³/₁₆" x 5 ¹⁴/₁₆" x h. 11 ¹³/₁₆"

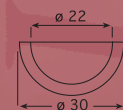

①

**LE COLONNE:
LE COMBINAZIONI**
Componibili; non portanti

②

**COLUMNS:
COMBINATIONS**
Modular; not supporting

③

**COLUMNAS
COMBINACIONES**
Apilable; no soportan peso

④

**COLUNAS
COMBINAÇÕES**
Intermutável; não portante



C C3351 H.Q.
+ C C3322 H.Q.
+ C C3323 H.Q.
H. 351 cm
(138 3/16")

C C3331 H.Q.
+ C C3322 H.Q.
+ C C3323 H.Q.
H. 353 cm
(139")

C C3323 H.Q.
+ C C3322 H.Q.
+ C C3323 H.Q.
H. 365 cm
(143 11/16")

C C3351 H.Q.
+ C C3332 H.Q.
+ C C3323 H.Q.
H. 351 cm
(138 3/16")

C C3331 H.Q.
+ C C3332 H.Q.
+ C C3323 H.Q.
H. 353 cm
(139")

C C3323 H.Q.
+ C C3332 H.Q.
+ C C3323 H.Q.
H. 365 cm
(143 11/16")

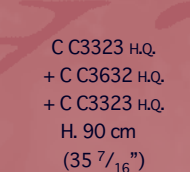
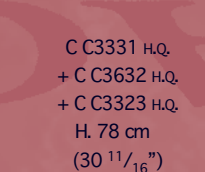
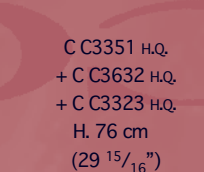
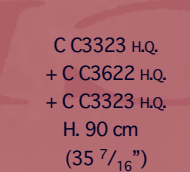
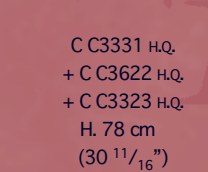
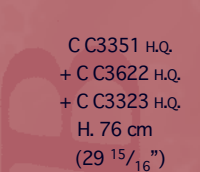

C C3351 H.Q.
+ C C3622 H.Q.
+ C C3323 H.Q.
H. 76 cm
(29 15/16")

C C3331 H.Q.
+ C C3622 H.Q.
+ C C3323 H.Q.
H. 78 cm
(30 11/16")

C C3323 H.Q.
+ C C3622 H.Q.
+ C C3323 H.Q.
H. 90 cm
(35 7/16")

C C3351 H.Q.
+ C C3632 H.Q.
+ C C3323 H.Q.
H. 76 cm
(29 15/16")

C C3331 H.Q.
+ C C3632 H.Q.
+ C C3323 H.Q.
H. 78 cm
(30 11/16")

C C3323 H.Q.
+ C C3632 H.Q.
+ C C3323 H.Q.
H. 90 cm
(35 7/16")

①

**LE MEZZE COLONNE:
LE COMBINAZIONI**

Componibili; non portanti

GB

**HALF COLUMNS:
COMBINATIONS**

Modular; not supporting

⑤

**MEDIAS COLUMNAS
COMBINACIONES**

No soportan peso; armables

②

**MEIAS COLUNAS
COMBINAÇÕES**

Não portante; Intermutável



C C3354 H.Q.
+ C C3325 H.Q.
+ C C3326 H.Q.
H. 351 cm
(138 3/16")

C C3334 H.Q.
+ C C3325 H.Q.
+ C C3326 H.Q.
H. 353 cm
(139")

C C3326 H.Q.
+ C C3325 H.Q.
+ C C3326 H.Q.
H. 365 cm
(143 11/16")

C C3354 H.Q.
+ C C3333 H.Q.
+ C C3326 H.Q.
H. 351 cm
(138 3/16")

C C3334 H.Q.
+ C C3333 H.Q.
+ C C3326 H.Q.
H. 353 cm
(139")

C C3326 H.Q.
+ C C3333 H.Q.
+ C C3326 H.Q.
H. 365 cm
(143 11/16")

①

**LE MEZZE COLONNETTE:
LE COMBINAZIONI**

Non portanti; componibili

GB

**HALF SMALL COLUMNS:
COMBINATIONS**

Not supporting; modular

⑤

**MEDIAS COLUMNETAS:
COMBINACIONES**

No soportan peso; armables

②

**MEIAS COLUNAS PEQUENAS:
COMBINAÇÕES**

Não portante; intermutável



C C3354 H.Q.
+ C C3633 H.Q.
+ C C3326 H.Q.
H. 76 cm
(29 15/16")

C C3334 H.Q.
+ C C3633 H.Q.
+ C C3326 H.Q.
H. 78 cm
(30 11/16")

C C3326 H.Q.
+ C C3633 H.Q.
+ C C3326 H.Q.
H. 90 cm
(35 7/16")

C C3354 H.Q.
+ C C3623 H.Q.
+ C C3326 H.Q.
H. 76 cm
(29 15/16")

C C3334 H.Q.
+ C C3623 H.Q.
+ C C3326 H.Q.
H. 78 cm
(30 11/16")

C C3326 H.Q.
+ C C3633 H.Q.
+ C C3326 H.Q.
H. 90 cm
(35 7/16")

I
LE ISTRUZIONI
PER IL MONTAGGIO

GB
ASSEMBLING
INSTRUCTIONS

E
INSTRUCCIONES
PARA EL MONTAJE

P
INSTRUÇÕES DE
MONTAGEM



È preferibile posare le cornici, gli angoli ed i rosoni prima di tappezzare le pareti. I prodotti devono essere applicati su pareti asciutte, pulite e sgrassate.

We suggest to install mouldings, corners and roses before wallpapering. Items must be applied on dry clean and ungreased surfaces.

Le aconsejamos colocar las molduras, los ángulos y los rosetones antes de pegar el papel tapiz. Asegúrese que la pared esté seca, limpia y sin grasa.

É preferível deixar descansar as molduras e as rosetas antes de aplicar nas paredes. Os produtos devem ser aplicados sob paredes secas, limpas e desengorduradas.

Sono sufficienti i seguenti accessori: cassetta per taglio, sega speciale Bovelacci, Classic Coll, Eurocoll, spatola, spugna, pittura, pennelli, cutter e metro.

You need only the following tools: mitre-box, Bovelacci special saw, glue Classic Coll, glue Eurocoll, spatula, sponge, paint, brush, cutter and metre.

Son suficientes los siguientes materiales; caja para cortes, sierra, Classic Coll, Eurocoll, espátula, esponja, pintura, pincel, cutter y metro.

São suficientes os seguintes acessórios: caixa para corte, serra especial Bovelacci, Classic Coll, Eurocoll, espátula, esponja, tinta, pincéis, cortador e metro.

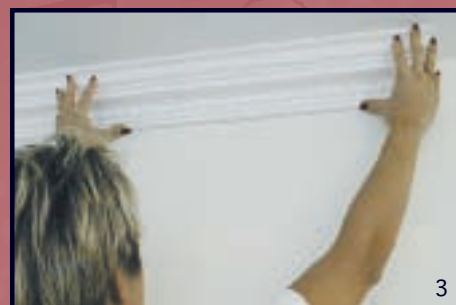
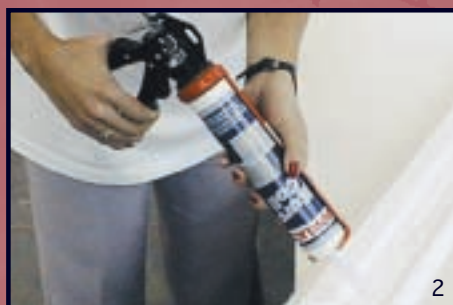

LE CORNICI

MOULDINGS

MOLDURAS

SANCAS

1. Iniziare a tagliare le cornici con la sega speciale Bovelacci in modo da realizzare gli angoli che vi servono. Controllate che combino.

1. Cut straight ends with special saw Bovelacci to make the type of corners you need. Check fit.

1. Corte la moldura para obtener el ángulo que necesita. Controle que la moldura calce.

1. Comece a cortar as molduras com serra especial Bovelacci de modo a fazer os ângulos que são úteis. Preste atenção para ver se estão combinando.

2. Stendere la colla speciale Classic Coll su entrambe le superfici posteriori dell'asta che andranno a contatto con la parete o il soffitto, nonchè fra le giunture (incidenza media: 1 cart. x 8 ml). Per l'installazione utilizzare anche chiodini in acciaio senza testa.

2. Apply the special glue Classic Coll on both back surfaces of the stick meant to lean on the wall and inside the joint (average incidence: 1 cart. x 8 ml). For installation also use steel nail without head.

2. Aplique el pegamento especial Classic Coll en las dos superficies posteriores del asta que se pegarán en la pared, en el techo y entre las juntas.

2. Espalhe a cola especial Classic Coll em ambas as superfícies posteriores que serão colocadas em contato com a parede ou teto e também entre as juntas (consumo médio 1 cart. x 8 ml). Se necessário, utilize também pregos sem cabeça.

3. Applicare la cornice alla parete con una leggera pressione. Dopo una settimana riempite con la colla Eurocoll ogni giuntura o spazio.

3. Press pieces into the corner with a light pressure. After a week fill all joints and gaps with Eurocoll glue.

(promedio de consumo: 1 cto. x 8 ml)
3. Presione delicadamente la moldura contra la pared. Después de una semana rellene con el pegamento Eurocoll cada una de las juntas y los espacios.

3. Aplicar a moldura na parede com uma leve pressão. Depois de uma semana preencher com a cola Eurocoll todos os espaços entre as junção.

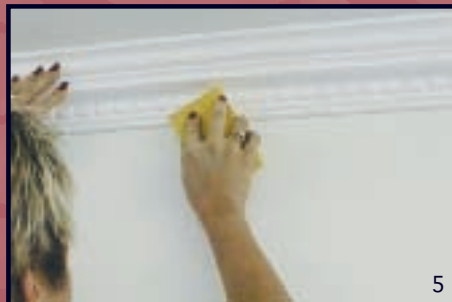

4. Togliete l'eccesso di colla con l'aiuto di una spatola.

4. Remove glue in excess by using a spatula.

4. Quite el exceso de pegamento con una espátula.

4. Retirar o excesso de cola com a ajuda de uma espátula.

5. Pulite quindi con l'aiuto di una spugna.

5. Wipe smooth with a clean damp sponge.

5. Limpie los residuos con una esponja.

5. Então limpar, com a ajuda de uma esponja.

6. Lasciate asciugare e rifinite con vernice a base d'acqua.

6. Let dry and apply water-based paint.

6. Deje secar y retoque con pintura a base de agua.

6. Deixe secar e faça o acabamento com tinta à base de água.



I ROSONI

1. Praticare col cutter un foro centrale nel rosone se è prevista l'applicazione di un lampadario.
2. Applicare la speciale colla Classic Coll lungo la circonferenza.
3. Appoggiare il rosone al soffitto nel punto desiderato. Per l'installazione utilizzare anche chiodini in acciaio senza testa. Per stuccare usare Eurocoll. Verniciare con idropitture.

CEILING CENTRES

1. Make a central hole in the middle of the ceiling centre by using a cutter.
2. Apply the special Classic Coll glue around the circumference.
3. Lean the centre on the ceiling. For installation also use steel nail without head. To fill all joints and gaps use Eurocoll glue. Apply water-based paint.

ROSETONES

1. Haga un agujero en el centro del rosetón.
2. Aplique el pegamento especial Eurocoll en toda la circunferencia.
3. Apoye el rosetón en el techo donde se desea colocar. Ponga la pintura a base de agua.

ROSETAS

1. Preparar com o um buraco central na roseta se estiver prevista a instalação de um lustre.
2. Aplicar a cola especial Classic Coll em toda a circunferência.
3. Apoiar a roseta ao teto no ponto desejado. Se necessário, utilize também pregos sem cabeça. Para preencher os vazios, utilize Eurocoll. Pintar com tinta à base de água.



ml t 280

IL COLLANTE: CLASSIC COLL

Collante speciale in pasta bianca (incidenza media: 1 cartuccia x 8 ml)
Temperatura di applicazione: +8°C ÷ +35°C
Temperatura d'impiego ad essiccazione avvenuta: -20°C ÷ +75°C
Conservazione: 10 mesi
Prima del montaggio si consiglia di testare la colla Classic Coll sul sottofondo
Per stuccare usare Eurocoll

GLUE: CLASSIC COLL

Special adhesive white paste (average incidence: 1 cart. x 8 ml)
Application temperature: +8°C ÷ +35°C
Temperature : -20°C ÷ +75°C
Shelf life: 10 months
Testing Classic Coll glue before applying is recommended
To fill all joints and gaps use Eurocoll glue

COLA: CLASSIC COLL

Pegamento especial en pasta blanca (promedio de consumo: 1 cto. x 8 ml)
Temperatura para la aplicación: +8°C ÷ +35°C
Temperatura de uso para el secado: -20 °C ÷ +75 °C
Conservación: 10 meses
Es aconsejable probar el pegamento revolviendo desde el fondo antes del montaje.
Para estucar utilizar Eurocoll.

COLA: CLASSIC COLL

Cola especial em pasta branca (consumo médio 1 cart. x 8 ml)
Temperatura de aplicação: +8 °C ÷ +35 °C
Temperatura de utilização e secagem: -20 °C ÷ +75 °C
Conservação: 10 meses
Antes da montagem aconselhasse testar a cola Classic Coll na parte de baixo.
Para preencher os vazios, utilize Eurocoll.



TILESTYL STARSTYL

I PANNELLI PER SOFFITTI
ED I CONTROSOFFITTI

TILES FOR CEILINGS
AND FALSE CEILINGS

ITALSTYL EUROSTYL EXTRASTYL CLASSICSTYL AMERICANSTYL

LE CORNICI, I ROSONI, LE TRAVI,
GLI ANGOLI ED I FREGI

IN POLISTIRENE ESTRUSO, ESPANSO, POLIMERI ESPANSI,
POLIURETANO E "POLISTRUTTURATO"

MOULDINGS, CEILING CENTRES, BEAMS,
CORNER BLOCKS AND DECORS

EXTRUDED AND EXPANDED PS, EXPANDED POLYMERS,
POLYURETHANE AND "POLISTRUTTURATO"



Le caratteristiche tecniche indicate nel presente catalogo vengono fornite a titolo indicativo e potranno essere modificate senza preavviso. Non devono quindi essere considerate a scopo di specificità.
The given values are indicative and can be changed without notice. They cannot be considered like a state.



PROFILSTYL I PROFILI PER LA CASA TRIMMINGS



BRICKSTYL PROFILI PER L'ESTERNO EXTERIOR MOULDINGS



OBJECTSTYL LOGGETTISTICA PATCHWORK OBJECTS



EUROSTYL LE COLONNE COLUMNS



WOODSTYL LE TRAVI IN POLIURETANO POLYURETHANE BEAMS



I MANICHINI MANNEQUINS



KRISTALSTYL OGGETTI TRASPARENTI TRANSPARENT OBJECTS

This leaflet and the designs embodied within are protected by copyright law and international treaties. Unauthorized reproduction of the leaflet or any portion of it or reproduction of any of the designs embodied therein may result in severe civil penalties and will be prosecuted to the maximum. All rights reserved, Bovelacci Forlì Italy.

per invio corrispondenza:
Bovelacci - Casella Postale 51, Uff. Post. Forlì succ. 8
I-47100 Forlì - ITALY
per carico merci:
Bovelacci Cargo - Via Fiume Ronco, 2
I-47100 Forlì - ITALY



Via del Commercio, 5
I-47100 Forlì - ITALY
Tel. +39 0543 721386
Tel. +39 0543 811611
Fax +39 0543 721127

