

# BOVELACCI



*Dott. Ing. Bovelacci Marco 2000*



## EUROSTYL

- ① LE CORNICI IN POLISTIRENE ESPANSO
- Ⓒ EXPANDED POLYSTYRENE MOULDINGS
- Ⓔ MOLDURAS DE POLIESTIRENO EXPANDIDO
- Ⓟ SANCAS EM POLISTIRENO EXPANDIDOS



EUROSTYL F3L, M62L, N49L  
I CLASSICI 3010 H.Q. A3010 H.Q.  
F3010 H.Q. 3430 H.Q. F3621 H.Q. L3210 H.Q.  
P3512 H.Q. P3591 H.Q. P3592 H.Q.  
I PROFILI PER LA CASA B110 LEGNO CHIARO

**BOVELACCI**



# BOVELACCI

## EUROSTYL

-  LE CORNICI IN POLISTIRENE ESPANSO
-  EXPANDED POLYSTYRENE MOULDINGS
-  ZIERPROFILE AUS FORMGESCHÄUMTEM POLYSTYROL
-  CORNICHES EN POLYSTYRÈNE EXPANSÉ
-  MOLDURAS DECORATIVAS EXPANDIDAS
-  SANCAS EXPANDIDAS
-  PS-GEËXPANDEERD SIERPROFIELEN
-  ΚΟΡΝΙΖΕΣ ΔΙΟΓΚΩΜΕΝΗΣ ΠΟΛΥΣΤΕΡΙΝΗΣ
-  DESENLI POLISTREN KARTONPIYER
-  EXPANDERADE POLYSTYREN LISTER
-  STUKKATURLISTER I POLYSTYRENE
-  STUKLISTER AF EKSPANDERET POLYSTYREN
-  STYROKSILISTAT
-  EKSPANDIRANE OKRASNE PROFILE IZ POLISTIRENA
-  EKSPANDIRANI POLISTIREN PROFILI
-  ПЛИНТУСА ЭКСПАНДИРОВАННЫЕ
-  LISTWY EKSPANDOWANE
-  LIŠTY POLYSTYREN EXPADOVANÝ
-  CORNISE DIN POLISTIREN EXPANS
-  EXPANDÁLT DÍSZLÉCEK
-  ПЛИНТУС ЕКПАНДОВАНИЙ
-  EKSPANDIRANI PROFILI
-  聚苯乙烯泡沫体的装饰
-  発砲スチロール製飾り縁

CORNICI IN POLISTIRENE ESPANSO - CLASSE 1  
EXPANDED PS MOULDINGS - CLASS B1

**BOVELACCI**

**I**  
LE CORNICI  
PER SOFFITTI

Cornici in polistirene  
espanso

Polistirene autoestinguente  
Classe 1  
Lunghezza: 1,25 ml per asta

**GB**  
CEILINGS  
MOULDINGS

Expanded polystyrene  
mouldings

Self extinguishing polystyrene  
Class B1  
Length: 1,25 lm (49 1/4")

**E**  
MOLDURAS  
PARA TECHOS

Molduras de poliestireno  
expandido

Poliestireno auto-extinguible  
Clase 1  
Longitud: 1,25 metros

**P**  
SANCAS  
PARA TETOS

Sancas em polistireno  
expandido

Polistireno auto-extinguível  
Classe 1  
Comprimento: 1,25 ml por barra

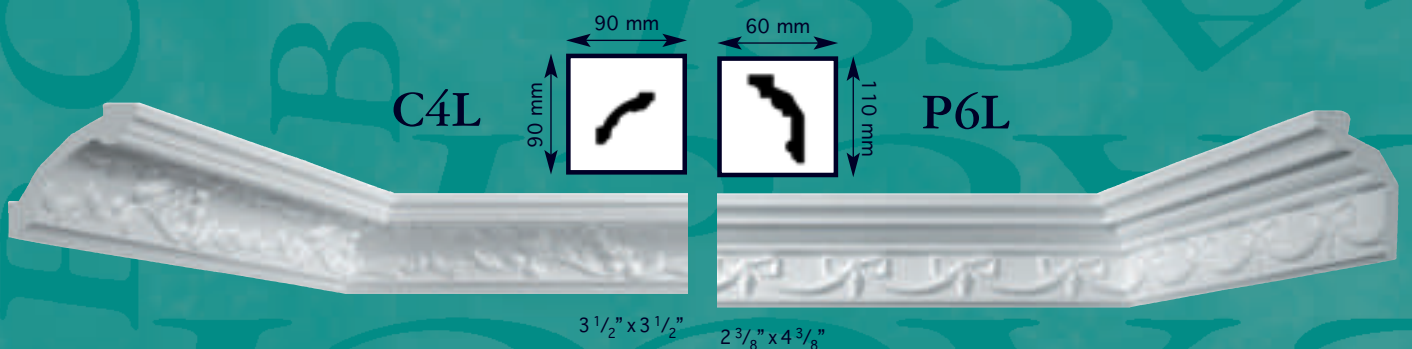
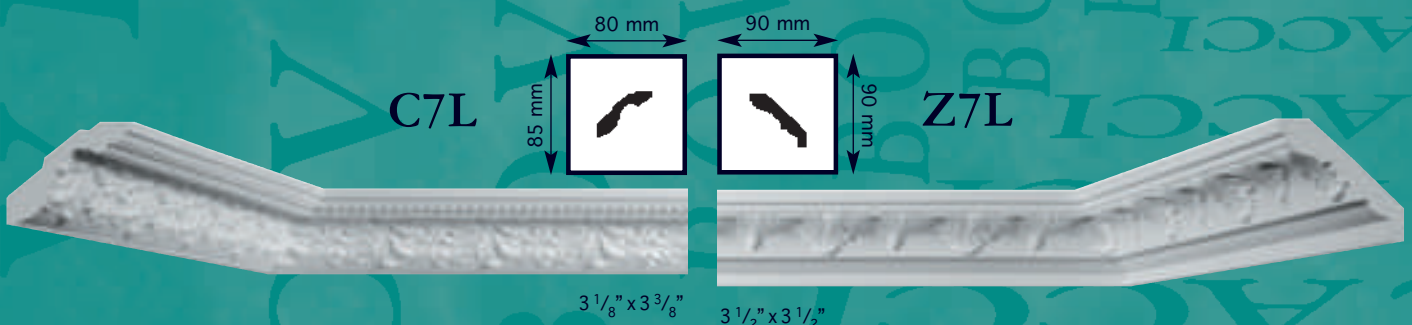
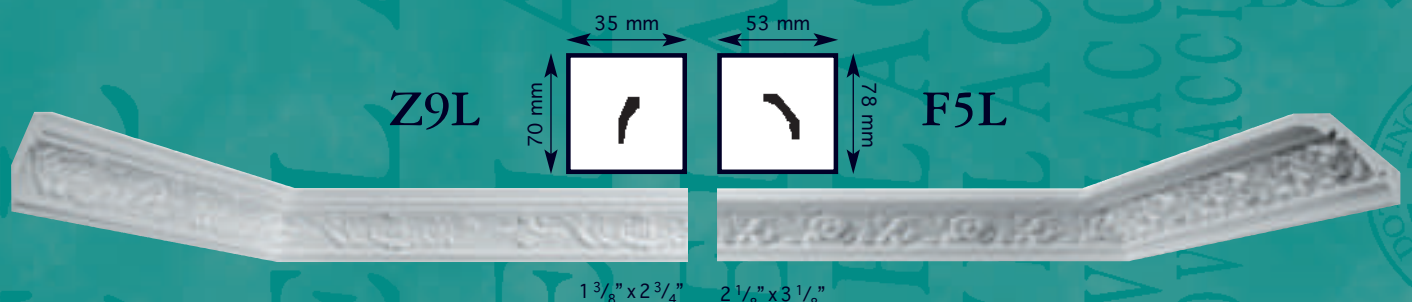
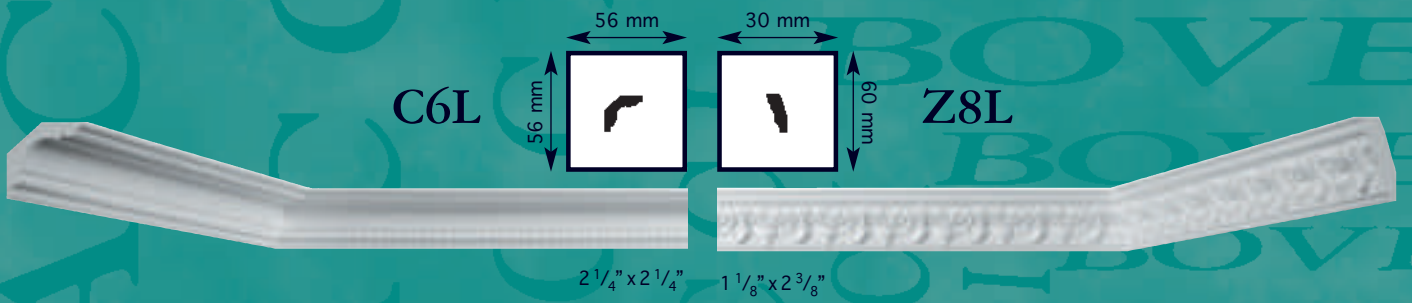

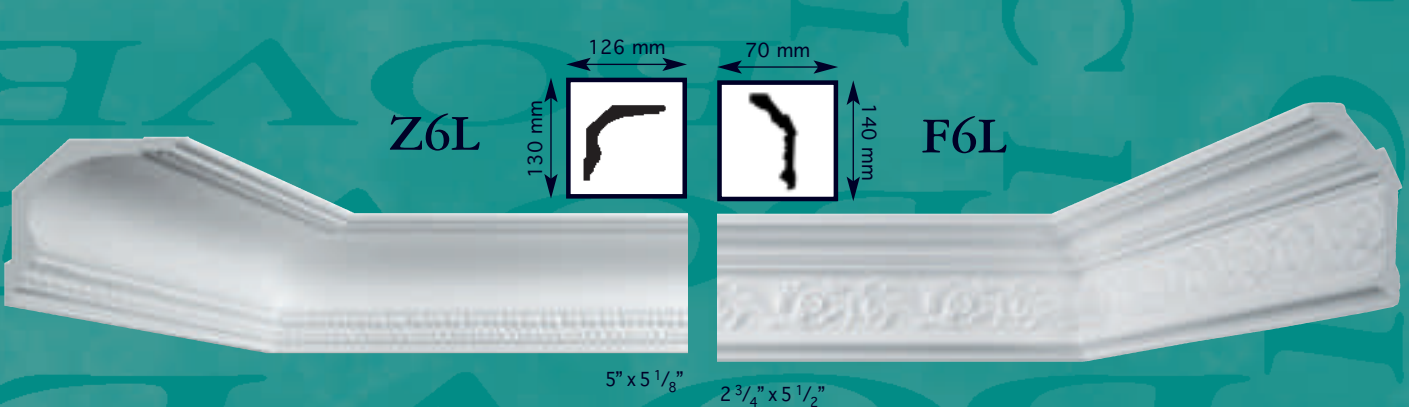
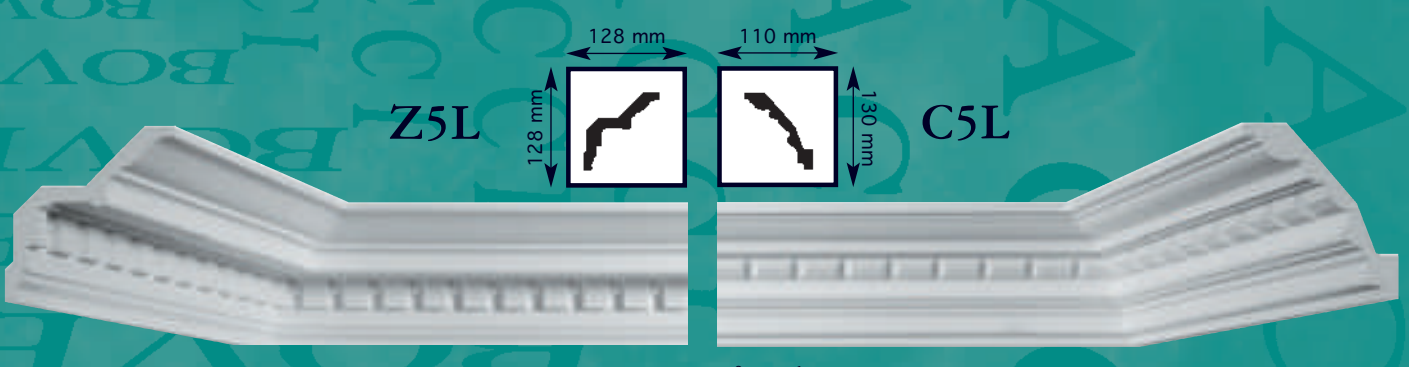
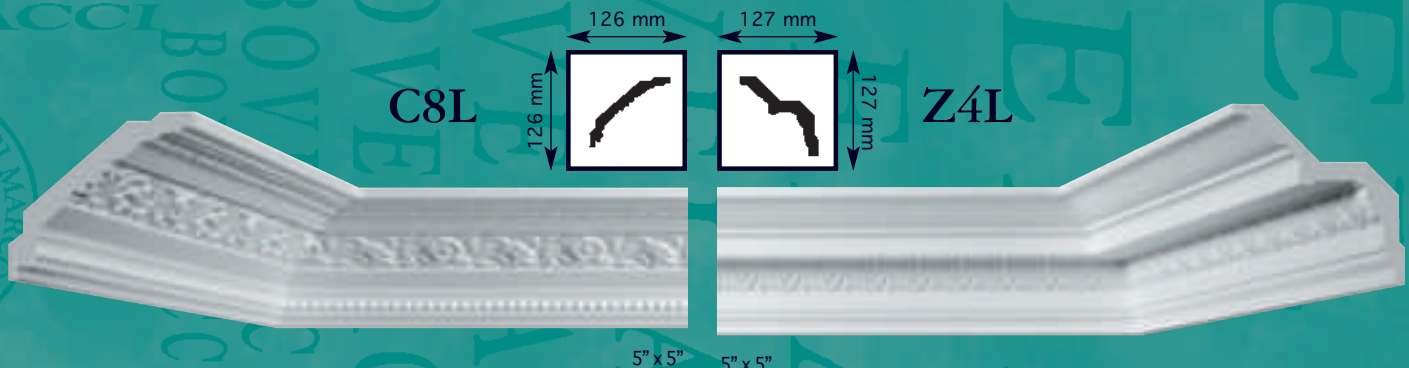
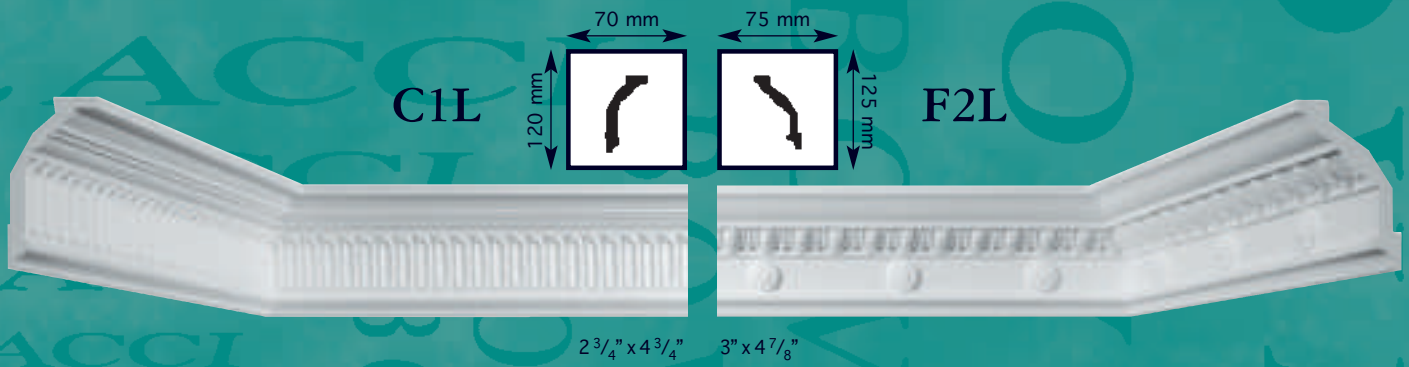
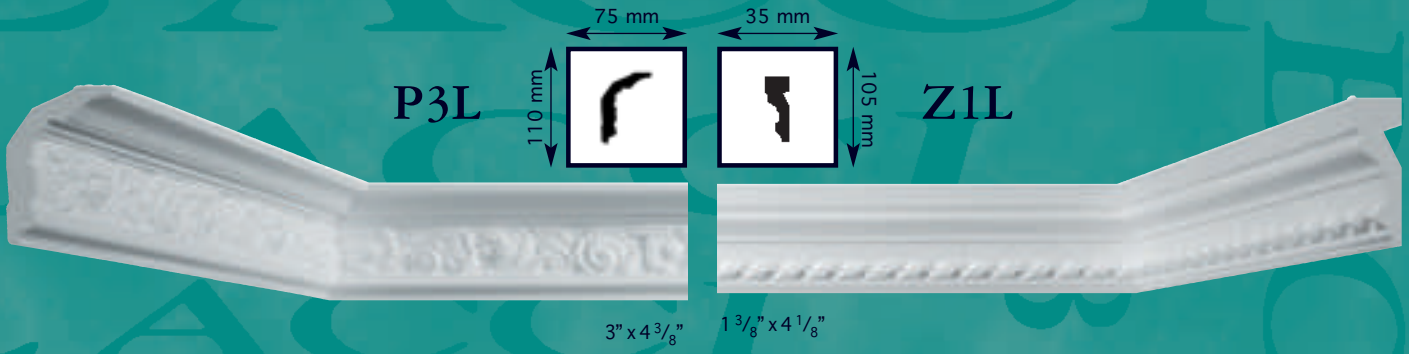

① Polistirene autoestinguente  
Classe 1  
Lunghezza: 1,25 ml per asta

Ⓒ Self extinguishing polystyrene  
Class B1  
Length: 1,25 lm (49 1/4")

Ⓔ Poliestireno auto-extinguibile  
Clase 1  
Longitud: 1,25 metros

Ⓟ Polistireno auto-extinguível  
Classe 1  
Comprimento: 1,25 ml por barra

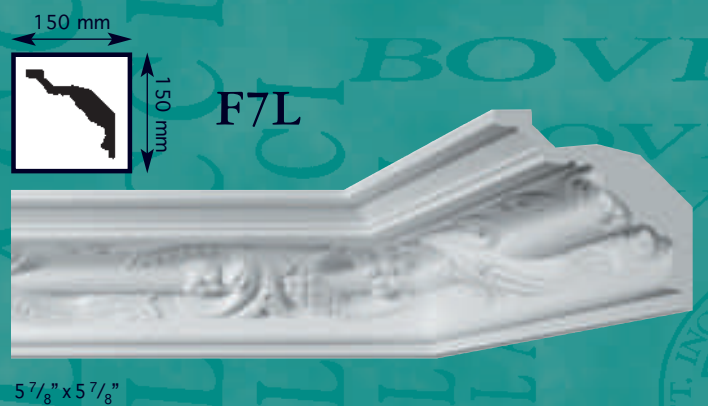

①  
**LE CORNICI  
ED I NASI  
PER SOFFITTI**

Nasi:  
Angolari Interni  
Angolari esterni  
Polistirene autoestinguente  
Classe 1  
Lunghezza: 1,25 ml per asta

ⓐ  
**CEILINGS  
MOULDINGS  
AND CORNERS**

Corner blocks:  
Inside corner blocks  
Outside corner blocks  
Self extinguishing polystyrene  
Class B1  
Length: 1,25 lm (49 1/4")

ⓔ  
**MOLDURAS Y  
ÁNGULOS  
PARA TECHOS**

Ángulos:  
Ángulos interiores  
Ángulos exteriores  
Poliestireno auto-extinguible  
Clase 1  
Longitud: 1,25 metros

Ⓟ  
**SANCAS E  
ÂNGULOS  
PARA TETOS**

Ângulos:  
Ângulos internos  
Ângulos externos  
Polistireno auto-extinguível  
Classe 1  
Comprimento: 1,25 ml por barra

ENP4LI



ENP4LE



ENP5LI



ENP5LE



ENR1LI



ENR1LE



ENZ2LI



ENZ2LE



ENZ3LI



ENZ3LE

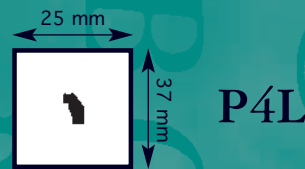

P4L

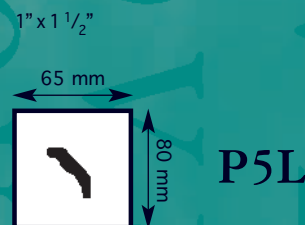
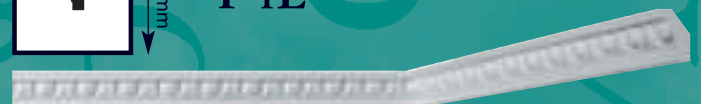

P5L

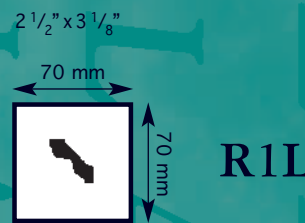

R1L

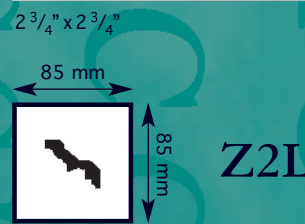

Z2L

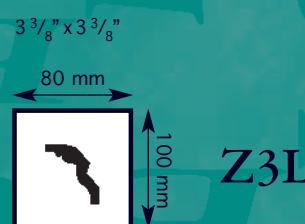

Z3L



**① LE CORNICI E GLI ANGOLI PER PARETI E SOFFITTI**

Polistirene autoestinguente  
Classe 1  
Lunghezza: 1,25 ml per asta

**② PANEL MOULDINGS AND CORNERS**

Self extinguishing polystyrene  
Class B1  
Length: 1,25 lm (49 1/4")

**③ MOLDURAS Y ÁNGULOS PARA PAREDES Y TECHOS**

Polistireno auto-extinguible  
Clase 1  
Longitud: 1,25 metros

**④ SANCAS E ÂNGULOS PARA PAREDES E TETOS**

Polistireno auto-extinguível  
Classe 1  
Comprimento: 1,25 ml por barra

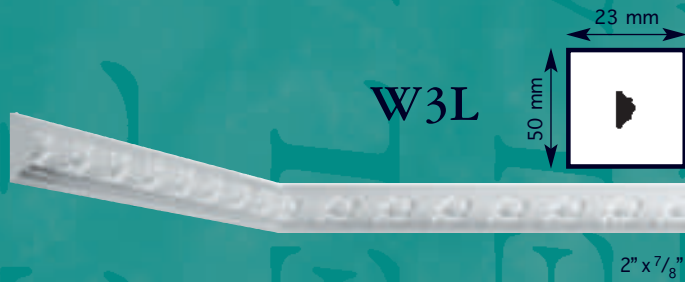

**EAC2L**  
23 x 23 - r. 14 cm



**EAW3L**  
24 x 24 - r. 14 cm



**EAC3L**  
31 x 25,5 - r. 14 cm

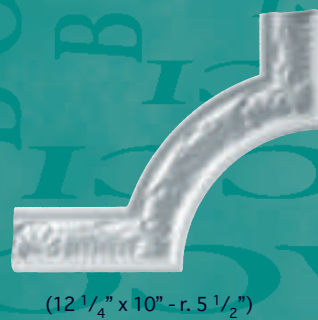

**EAW0L**  
24 x 24 - r. 14 cm



**EAW1L**  
23 x 23 - r. 14 cm



(9" x 9" - r. 5 1/2")

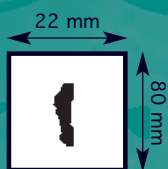

**W1L**

3 1/8" x 7/8"



**EAW2L**  
24 x 24 - r. 14 cm



(9 1/2" x 9 1/2" - r. 5 1/2")

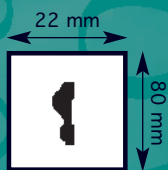

**W2L**

3 1/8" x 7/8"



**EAW4L**  
30 x 30 - r. 14 cm



(11 3/4" x 11 3/4" - r. 5 1/2")

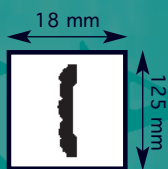

**W4L**

4 7/8" x 3 3/4"



**EAW5L**  
26 x 26 - r. 13 cm



(10 1/4" x 10 1/4" - r. 5 1/8")

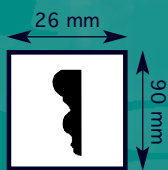

**W5L**

3 1/2" x 1"



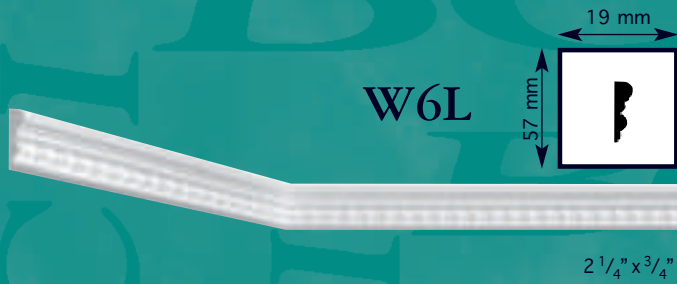

IL DISPLAY EUROSTYL



**EAW7L**

26 x 26 - r. 13 cm



(10 1/4" x 10 1/4" - r. 5 1/8")



**EAW8L**

28 x 28 - r. 14 cm



(11" x 11" - r. 5 1/2")



① I NASI UNIVERSALI  
PER SOFFITTI

Ⓜ UNIVERSAL  
CORNER BLOCKS

Ⓔ ÁNGULOS  
UNIVERSALES

Ⓟ ÂNGULOS  
UNIVERSAIS

mm 30x30



**ENLP30I**

dim=mm 30x30 L=cm 4x4



**ENLP30C**

dim=mm 30x30 L=cm 3,5



**ENLP30E**

dim=mm 30x30 L=cm 4x4



**ENDP30I**

dim=mm 30x30 L=cm 4x4



**ENDP30C**

dim=mm 30x30 L=cm 3,5



**ENDP30E**

dim=mm 30x30 L=cm 4x4

consigliati per cornici Eurostyl:

for Eurostyl mouldings:

para molduras Extrastyl:

para sancas Extrastyl:

mm 50x50: P4L



**ENLM50I**

dim=mm 50x50 L=cm 7x7



**ENLM50C**

dim=mm 50x50 L=cm 5,5



**ENLM50E**

dim=mm 50x50 L=cm 7x7



**ENDM50I**

dim=mm 50x50 L=cm 7x7



**ENDM50C**

dim=mm 50x50 L=cm 5,5



**ENDM50E**

dim=mm 50x50 L=cm 7x7

consigliati per cornici Eurostyl:

for Eurostyl mouldings:

para molduras Extrastyl:

para sancas Extrastyl:

mm 80x80: C6L, F5L, P5L, R1L, Z8L, Z9L



**ENLG80I**

dim=mm 80x80 L=cm 10,5x10,5



**ENLG80C**

dim=mm 80x80 L=cm 8,5



**ENLG80E**

dim=mm 80x80 L=cm 10,5x10,5



**ENDG80I**

dim=mm 80x80 L=cm 10,5x10,5



**ENDG80C**

dim=mm 80x80 L=cm 8,5



**ENDG80E**

dim=mm 80x80 L=cm 10,5x10,5

consigliati per cornici Eurostyl:

for Eurostyl mouldings:

para molduras Extrastyl:

para sancas Extrastyl:

mm 110x110: C1L, C4L, P3L, P6L, Z2L, Z3L, Z9L, C7L



**ENLXG110I**

dim=mm 110x110 L=cm 13,5x13,5



**ENLXG110C**

dim=mm 110x110 L=cm 11,5



**ENLXG110E**

dim=mm 110x110 L=cm 13,5x13,5



**ENDXG110I**

dim=mm 110x110 L=cm 13,5x13,5



**ENDXG110C**

dim=mm 110x110 L=cm 11,5



**ENDXG110E**

dim=mm 110x110 L=cm 13,5x13,5



# EUROSTYL

-  I ROSONI
-  CEILING CENTERS
-  ROSETTEN
-  ROSACES POUR PLAFONDS
-  ROSETONES
-  ROSETAS PARA TETO
-  ROZETTEN
-  ΚΟΡΝΙΖΕΣ ΔΙΟΓΚΩΜΕΝΗΣ ΠΟΛΥΣΤΕΡΙΝΗΣ
-  TAVAN GÖBEKLERİ
-  TAKROSETTER
-  ROSETTER
-  ROSETTER
-  ROSETIT
-  ROZETE
-  ROZETA
-  РОЗЕТКИ ДЛЯ ПОТОЛКА
-  ROZETY
-  ROZETY
-  ROZETA PENTRU TAVANURI
-  ROZETTÁK
-  РОЗЕТКИ ДЛЯ СТЕЛІ
-  РОЗЕТКИ ЗА ТАВАН
-  天花
-  発砲スチロール製バラ窓



**C00**  
ø 6,5 cm  
(2 1/2")



**B13**  
9 x 9 cm  
(3 1/2" x 3 1/2")



**B2L**  
ø 12 cm  
(4 3/4")



**B1L**  
ø 15 cm  
(5 7/8")



**R15**  
ø 15 cm  
(5 7/8")



**R03L**  
ø 15,5 cm  
(6 1/8")



**R16**  
ø 16 cm  
(6 1/4")



**R19**  
ø 19 cm  
(7 1/2")



**R21**  
ø 21 cm  
(7 7/8")



**S1**  
ø 22 cm  
(8 5/8")



**C21**  
ø 24 cm  
(9 1/2")



**B21**  
ø 28 cm  
(11")



**R25**  
ø 25 cm  
(9 7/8")



**R29**  
ø 29 cm  
(11 3/8")



**M51**  
ø 30 cm  
(11 3/4")



**R31**  
ø 31 cm  
(12 1/4")

POLISTIRENE ESPANSO - CLASSE 1  
EXPANDED POLYSTYRENE - CLASS B1





**R32**  
 ø 32 cm  
 (12 5/8")



**C22**  
 ø 33 cm  
 (13")



**R33**  
 ø 33 cm  
 (13")



**B24**  
 ø 34 cm  
 (13 3/8")



**R38**  
 ø 38 cm  
 (15")



**R40**  
 ø 40 cm  
 (15 3/4")



**R6**  
 ø 41 cm  
 (16 1/8")



**R41**  
 ø 41 cm  
 (16 1/8")



**C15**  
 ø 41 cm  
 (16 1/8")



**R43**  
 43 x 30 cm  
 (16 7/8" x 11 3/4")



**R42**  
 ø 42 cm  
 (16 1/2")



**R44**  
 ø 44 cm  
 (17 3/8")



**C25**  
ø 44 cm  
(17 <sup>3</sup>/<sub>8</sub>"



**M52**  
ø 45 cm  
(17 <sup>3</sup>/<sub>4</sub>"



**R45**  
ø 45 cm  
(17 <sup>3</sup>/<sub>4</sub>"



**R48**  
ø 48 cm  
(19")



**C33**  
ø 47 cm  
(18 <sup>1</sup>/<sub>2</sub>"



**R49**  
ø 49 cm  
(19 <sup>1</sup>/<sub>4</sub>"



**O1**  
53 x 43 cm  
(20 <sup>7</sup>/<sub>8</sub>" x 16 <sup>7</sup>/<sub>8</sub>"



**R50**  
ø 50 cm  
(19 <sup>5</sup>/<sub>8</sub>"



DECORKIT  
ROSONI



**R51**  
ø 51 cm  
(20 <sup>1</sup>/<sub>8</sub>"



**R55**  
 ø 55 cm  
 (21 5/8")



**R53**  
 ø 53 cm  
 (20 7/8")



**R60**  
 ø 60 cm  
 (23 5/8")



**R61**  
 ø 61 cm  
 (24")

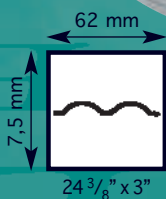

**R62**  
 ø 62 cm  
 (24 3/8")



**R64**  
 ø 64 cm  
 (25 1/4")



**C27**  
 ø 66 cm  
 (26")

①  
IL ROSONE  
COMPONIBILE R52



**R52**  
ø 52 cm  
(20 1/8")

Esempi di realizzazione:

②  
COMPOSING  
CEILING CENTRE R52



**RF 803/52 DG**  
L.43 x p.3,5 x H.36 cm  
(1/4 di cerchio ø 52 cm)  
(L. 16 15/16" x d. 1 6/16" x H. 14 3/16")

Examples of realization:

③  
ROSETÓN  
ARMABLE R52



**RF 803/52 DP**  
L.43 x p.4 x H.23,5 cm  
(1/4 di cerchio ø 52 cm)  
(L. 16 15/16" x d. 1 9/16" x H. 9 4/16")

Ejemplos de empleo:

④  
ROSETA PARA TETO  
R52 A COMPOSIÇÃO



**RF 803/52 L**  
L.40 x H.10 cm  
(1/4 di cerchio ø 52 cm)  
(L. 15 12/16" x H. 3 15/16")

Algumas realizações:



R52 +  
2 x RF 803/52 DG  
2 x RF 803/52 DP



R52 +  
4 x RF 803/52 DG



R52 +  
4 x RF 803/52 DP



2 x RF 803/52 DG +  
2 x RF 803/52 L

①  
LE MENSOLE ED  
I FREGI

**F21L**

L.14 x p.3 x H.8,5 cm  
(L. 5 1/2" x d. 1 1/8" x H. 3 3/8")

**F54L**

L.12,7 x p.3 x H.12,8 cm  
(L. 5" x d. 1/8" x H. 5")

**F24L**

L.16 x p.5 x H.26 cm  
(L. 6 1/4" x d. 2" x H. 10 1/4")

**M62L**

L.17 x p.12 x H.26 cm  
(L. 6 3/4" x d. 4 3/4" x H. 10 1/4")

②  
CORBELS AND  
DECORATIONS

**F36L**

L.11,7 x p.4 x H.16 cm  
(L. 4 5/8" x d. 1 5/8" x H. 6 1/4")

**M23L**

L.11 x p.6,5 x H.14,5 cm  
(L. 4 3/8" x d. 2 1/2" x H. 5 3/4")

**P02L**

L.32 x p.8 x H.22 cm  
(L. 12 5/8" x d. 3 1/8" x H. 8 5/8")

**M25L**

L.20 x p.11 x H.32 cm  
(L. 7 7/8" x d. 4 3/4" x H. 12 5/8")

③  
MENSOLAS Y  
DECORACIONES

**ANGELO1L**

L.12,5 x p.4 x H.9 cm  
(L. 4 7/8" x d. 1 5/8" x H. 3 1/2")

**M11L**

L.11,5 x p.7 x H.17 cm  
(L. 4 1/2" x d. 2 3/4" x H. 6 3/4")

**M03L**

L.19,5 x p.10 x H.20 cm  
(L. 7 5/8" x d. 3 7/8" x H. 7 7/8")

**DECORKIT  
FREGI**



**EF50NL**

L.50 x p.4 x H.38 cm  
(L.19 5/8" x d.1 5/8" x H.15")



**EF62GL**

L.62 x p.4 x H.30 cm  
(L.24 3/8" x d.1 5/8" x H.11 3/4")



**SOLE E LUNA GRANDE**

ø 39 cm  
(ø 15")



**N49L**

L. 28 x p.7 x H. 49 cm  
(L.11" x d.2 3/4" x H.19 1/4")



**LE ISTRUZIONI DI MONTAGGIO**

**INSTALLATION INSTRUCTIONS**

**INSTRUCCIONES PARA EL MONTAJE**

**INSTRUÇÕES DE MONTAGEM**

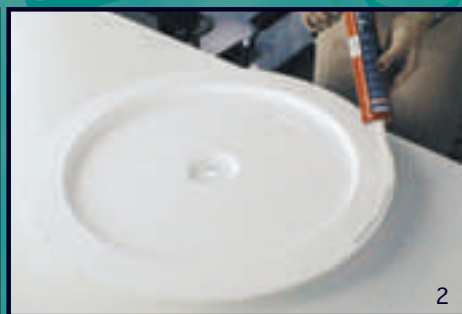

1. Praticare col cutter un foro centrale nel rosone se è prevista l'applicazione di un lampadario.  
2. Applicare la speciale colla Eurocoll lungo la circonferenza.  
3. Appoggiare il rosone al soffitto nel punto desiderato. Verniciare con idropittura.

1. Make a central hole in the middle of the ceiling centre by using a cutter.  
2. Apply the special Eurocoll glue around the circumference.  
3. Lean the centre on the ceiling. Apply water-based paint.

1. Haga un agujero en el centro del rosetón.  
2. Aplique el pegamento especial Eurocoll en toda la circunferencia.  
3. Apoye el rosetón en el techo donde se desea colocar. Ponga la pintura a base de agua.

1. Preparar com o um buraco central na roseta se estiver prevista a instalação de um lustre.  
2. Aplicar a cola especial Eurocoll em toda a circunferência.  
3. Apoiar a roseta ao teto no ponto desejado. Pintar com tinta à base de água.

①  
**LE COLONNE**

Le colonne in polistirolo espanso possono essere tinteggiate con vernici a base d'acqua

Alta densità (kg. 50/m<sup>3</sup>)  
Componibili; non portanti



**35SL**  
COLONNA  
CORINZIA LISCIA  
H. 80 cm  
(31 1/2")

②  
**COLUMNS**

Our expanded polystyrene columns may be decorated with water-based paints

High density (kg. 50/m<sup>3</sup>)  
Modular; not supporting



③  
**COLUMNAS**

Las columnas de poliestireno expandido pueden ser pintadas con pinturas a base de agua

Alta densidad (kg. 50/m<sup>3</sup>)  
No puede soportar peso; armables









④  
**COLONAS**

As colunas de isopor expandido podem ser pintadas com tinta à base de água

Alta densidade (kg. 50/m<sup>3</sup>)  
Não portante; intermutável



**36SR**  
COLONNA  
CORINZIA RIGATA  
H. 80 cm  
(31 1/2")

ARTICOLO	DESCRIZIONE
 35 SL	Colonna standard liscia corinzia 35 x 35 x h 80 cm Standard smoothed corinthian column (13 3/4" x 13 3/4" x h 31 1/2")
 36 SR	Colonna standard rigata corinzia 35 x 35 x h 80 cm Standard fluted corinthian column (13 3/4" x 13 3/4" x h 31 1/2")
 40 IL	Colonna standard liscia ionica 41 x 41 x h 70 cm Standard smoothed ionic column (16 1/8" x 16 1/8" x h 27 1/2")
 39 IR	Colonna standard rigata ionica 41 x 41 x h 70 cm Standard fluted ionic column (16 1/8" x 16 1/8" x h 27 1/2")
 31 BA	Base 35 x 35 x h 23 cm (13 3/4" x 13 3/4" x 9")
 32 CA	Capitello corinzio 35 x 35 x h 27 cm Corinthian capital (13 3/4" x 13 3/4" x 10 5/8")
 38 CI	Capitello ionico 41 x 41 x h 17 cm Ionic capital (16 1/8" x 16 1/8" x 6 3/4")
 34 RT	Tronco rigato h 30 cm ø 22,5 cm Fluted pillar (h 11 3/4" x ø 8 7/8")
 33 LT	Tronco liscio h 30 cm ø 22,5 cm Smoothed pillar (h 11 3/4" x ø 8 7/8")



**40IL**  
COLONNA  
IONICA LISCIA  
H. 70 cm  
(27 1/2")



**39IR**  
COLONNA  
IONICA RIGATA  
H. 70 cm  
(27 1/2")



①

**LE LESENE**

Componibili; non portanti

Ⓒ

**PILASTERS**

Modular; not supporting

Ⓔ

**PILARES**

No puede soportar peso; apilable

Ⓐ

**LESENAS**

Não portante; Intermutável



**EL01P**

**LESENA PICCOLA**  
H. 313 cm (123 1/4")

(EL01CP, 2xEL01TTP,  
2xEL01TP, EL01BP)



**EL01CP**

**Capitello lesena piccola**  
L. 17,5 x p. 5,5 - H. 17 cm

*Capitel small pilaster*  
(L. 6 7/8" x d. 2 1/8" - H. 6 3/4")



**EL01TTP**

**Terminale tronco lesena piccola**  
L. 11,5 x p. 2,5 - H. 10 cm

*Pillar end, small pilaster*  
(L. 4 1/2" x d. 1" - H. 3 7/8")



**EL01TP**

**Tronco lesena piccola**  
L. 11,5 x p. 2,5 - H. 125 cm

*Pillar small pilaster*  
(L. 4 1/2" x d. 1" - H. 49 1/4")



**EL01TTP**

**Terminale tronco lesena piccola**  
L. 11,5 x p. 2,5 - H. 10 cm

*Pillar end, small pilaster*  
(L. 4 1/2" x d. 1" - H. 3 7/8")



**EL01BP**

**Base lesena piccola**  
L. 11,5 x p. 3,5 - H. 26 cm

*Base small pilaster*  
(L. 4 1/2" x d. 1 3/8" - H. 10 1/4")



**EL02G**

**LESENA GRANDE**  
H. 313 cm (123 1/4")

(EL02CG, 2xEL02TTG,  
2xEL02TG, EL02BG)



**EL02CG**

**Capitello lesena grande**  
L. 21,5 x p. 6,5 - H. 17 cm

*Capitel big pilaster*  
(L. 8 1/2" x d. 2 1/2" - H. 6 3/4")



**EL02TTG**

**Terminale tronco lesena grande**  
L. 14 x p. 2,5 - H. 10 cm

*Pillar end, big pilaster*  
(L. 5 1/2" x d. 1" - H. 3 7/8")



**EL02TG**

**Tronco lesena grande**  
L. 14 x p. 2,5 - H. 125 cm

*Pillar big pilaster*  
(L. 5 1/2" x d. 1" - H. 49 1/4")



**EL02TTG**

**Terminale tronco lesena grande**  
L. 14 x p. 2,5 - H. 10 cm

*Pillar end, big pilaster*  
(L. 5 1/2" x d. 1" - H. 3 7/8")



**EL02BG**

**Base lesena grande**  
L. 14 x p. 3,5 - H. 26 cm

*Base big pilaster*  
(L. 5 1/2" x d. 1 3/8" - H. 10 1/4")

**LE ISTRUZIONI DI MONTAGGIO**

1. Assemblare le colonne secondo la composizione preferita ed incollate i componenti con Eurocoll
2. Dopo una settimana stuccate le giunture con lo stesso collante utilizzando una normale spatola
3. Rimuovere quindi la colla in eccesso con una spugna bagnata

**INSTALLATION INSTRUCTIONS**

1. Compose columns according to your favourite combination and fix components with Eurocoll.
2. After a week fill all joints and gaps with the same adhesive.
3. Wipe off excess glue with a clean damp sponge.

**INSTRUCCIONES PARA EL MONTAJE**

1. Arme las columnas como desea y pegue las partes con Eurocoll.
2. Estuque las juntas con el mismo pegamento usando una espátula.
3. Remueva el exceso de pegamento con una esponja mojada.

**INSTRUÇÕES DE MONTAGEM**

1. Colocar as colunas conforme a composição preferida e colar os componentes com Eurocoll.
2. Finalizar as junções com a mesma cola utilizando uma espátula normal.
3. Remover então a cola em excesso com uma esponja embebida.

①  
LE ISTRUZIONI  
PER IL MONTAGGIO

②  
ASSEMBLING  
INSTRUCTIONS

③  
INSTRUCCIONES  
PARA EL MONTAJE

④  
INSTRUÇÕES DE  
MONTAGEM



È preferibile posare le cornici, gli angoli ed i rosoni prima di tappezzare le pareti. I prodotti devono essere applicati su pareti asciutte, pulite e sgrassate.

Sono sufficienti i seguenti accessori: cassetta per taglio, sega speciale BOVELACCI, Eurocoll, spatola, spugna, pittura, pennelli, cutter e metro.

We suggest to install mouldings, corners and roses before wallpapering. Items must be applied on dry clean and ungreased surfaces.

You need only the following tools: mitre-box, BOVELACCI special saw, glue Eurocoll, spatula, sponge, paint, brush, cutter and metre.

Le aconsejamos colocar las molduras, los ángulos y los rosetones antes de pegar el papel tapiz. Asegúrese que la pared esté seca, limpia y sin grasa.

Son suficientes los siguientes materiales; caja para cortes, sierra, Eurocoll, espátula, esponja, pintura, pincel, cutter y metro.

É preferível deixar descansar as molduras e as rosetas antes de aplicar nas paredes. Os produtos devem ser aplicados sob paredes secas, limpas e desengorduradas.

São suficientes os seguintes acessórios: caixa para corte, serrote, Eurocoll, espátula, esponja, tinta, pincéis, cortador e metro.

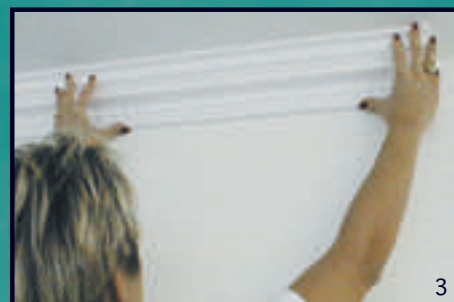
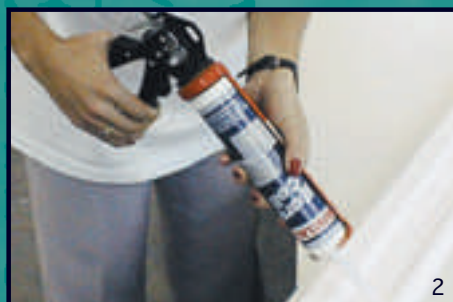

1. Iniziare a tagliare le cornici in modo da realizzare gli angoli che vi servono. Controllate che combinino.

2. Stendere la colla speciale Eurocoll su entrambe le superfici posteriori dell'asta che andranno a contatto con la parete o il soffitto, nonchè fra le giunture (incidenza media: 1 cart. x 10 ml).

3. Applicare la cornice alla parete con una leggera pressione. Dopo una settimana riempiate con la colla ogni giuntura o spazio.

1. Cut straight ends to make the type of corners you need. Check fit.

2. Apply the special glue Eurocoll on both back surfaces of the stick meant to lean on the wall and inside the joint (average incidence: 1 cart. x 10 ml).

3. Press pieces into the corner with a light pressure. After a week fill all joints and gaps with glue.

1. Corte la moldura para obtener el ángulo que necesita. Controle que la moldura calce.

2. Aplique el pegamento especial Eurocoll en las dos superficies posteriores del asta que se pegarán en la pared, en el techo y entre las juntas. (promedio de consumo: 1 cto. x 10 ml)

3. Presione delicadamente la moldura contra la pared. Después de una semana rellene con el pegamento cada una de las juntas y los espacios.

1. Comece a cortar as molduras de modo a fazer os ângulos que são úteis. Preste atenção para ver se estão combinando.

2. Espalhe a cola especial Eurocoll em ambas as superfícies posteriores que serão colocadas em contato com a parede ou teto e também entre as juntas. (consumo médio 1 cart. x 10 ml)

3. Aplicar a moldura na parede com uma leve pressão. Depois de uma semana preencher com a cola todos os espaços entre as junções.

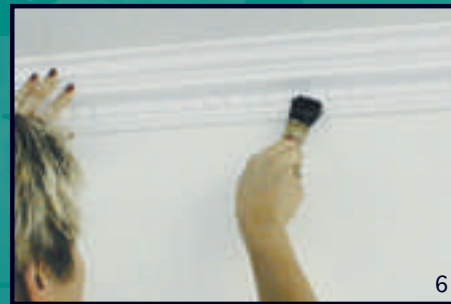

4. Togliete l'eccesso di colla con l'aiuto di una spatola.

4. Remove glue in excess by using a spatula.

4. Quite el exceso de pegamento con una espátula.

4. Retirar o excesso de cola com a ajuda de uma espátula.

5. Pulite quindi con l'aiuto di una spugna.

5. Wipe smooth with a clean damp sponge.

5. Limpie los residuos con una esponja.

5. Então limpar, com a ajuda de uma esponja.

6. Lasciate asciugare e rifinite con vernice a base d'acqua.

6. Let dry and apply water-based paint.

6. Deje secar y retoque con pintura a base de agua.

6. Deixe secar e faça o acabamento com tinta à base de água.

### EUROCOLL



mlt 310 - Kg 7 - Kg 1,8

Collante speciale per polistirene in pasta bianca (incidenza media: 1 cart. x 10 ml)

Temperatura di applicazione: +8 °C ÷ +30 °C

Temperatura d'impiego ad essiccazione avvenuta: +0 °C ÷ +55 °C

Conservazione: 10 mesi

Teme il gelo

Lasciare asciugare per una settimana, poi stuccare con Eurocoll e rifinire con una vernice a base d'acqua

Prima del montaggio si consiglia di testare la colla sul sottofondo

Special adhesive for polystyrene white paste (average incidence: 1 cart. x 10 lm)

Application temperature: +8 °C ÷ +30 °C

Temperature stability: +0 °C ÷ +55 °C

Shelf life: 10 months

Keep away from chill

Let dry for a week, before filling up the joints with Eurocoll and finishing with water-based paint

Testing glue before applying is recommended

Pegamento especial en pasta blanca (promedio de consumo: 1 cto. x 10 ml)

Temperatura de aplicación: +8°C ÷ +30°C

Temperatura de uso para el secado: +0 °C ÷ +55 °C

Conservación: 10 meses

No compatible con clima congelado Después de una semana rellene con el pegamento Eurocoll cada una de las juntas y los espacios. Es aconsejable si se remueve el pegamento desde el fondo antes del montaje.

Cola especial em pasta branca (consumo médio 1 cart. x 10 ml)

Temperatura de aplicação: +8 °C ÷ +30 °C

Temperatura de utilização e secagem: +0 °C ÷ +55 °C

Conservação: 10 meses

Não conservar em ambiente gelado Deixar secar durante uma semana, depois finalizar com Eurocoll e finalizar com uma tinta à base de água Antes da montagem aconselha-se testar a cola na parte de baixo



### LA SEGA SPECIALE

L. 50 cm

### LA CASSETTA PER TAGLIO

Dim. int. 16 x 20 x L. 50 cm

### SPECIAL SAW

L. 50 cm

### MITRE-BOX

Dim. int. 16 x 20 x L. 50 cm

### SIERRA ESPECIAL

L. 50 cm

### CAJA PARA CORTE

Dim. int. 16 x 20 x L. 50 cm

### SERRA ESPECIAL

L. 50 cm

### CAIXA DE CORTE

Dim. int. 16 x 20 x C. 50 cm

① **LE TRAVI EUROSTYL**

Travi in polistirene espanso  
Polistirene autoestinguento  
Non portanti  
Classe 1  
Lunghezza: 2 ml per asta

② **EUROSTYL BEAMS**

Expanded polystyrene beams  
Self extinguishing polystyrene  
Not supporting  
Class B1  
Length: 2 ml (78 3/4")

③ **VIGAS EUROSTYL**

Vigas de poliestireno expandido  
Poliestireno auto-extinguible  
No puede soportar peso  
Clase 1  
Longitud: 2 metros

④ **BARROTES EUROSTYL**

Barrotes em polistireno expandidos  
Polistireno auto-extinguível  
Não portante  
Classe 1  
Comprimento: 2 ml por barra

**ET7,5**  
7,5x5 cm  
(3" x 2")



**ET15**  
15,5x10 cm  
(6 1/8" x 3 7/8")



**ET30**  
30,5x20 cm  
(12" x 7 7/8")



**TFG H.Q.**

per trave ET7,5 ET15 ET30  
LA FASCIA CHIODATA  
COPRIGIUNTO IN GOMMA  
*Iron-like joint strip,  
rubber joint cover*

**LA PANNELLATURA PDZ**

Lastre in polistirene espanso  
autoestinguento  
Classe 1  
Lunghezza: 1,25 per lastra

**PANELS PDZ**

Expanded polystyrene panels  
self extinguishing  
Class B1  
Length: 1,25 ml (49 1/4")

**TABLAS PDZ**

Losas de poliestireno expandido  
Poliestireno auto-extinguible  
Clase 1  
Longitud: 1,25 metros

**TÁBUAS PDZ**

Tabuas em polistireno expandidos  
Polistireno auto-extinguível  
Classe 1  
Comprimento: 1,25 ml por barra

125 x 17 - sp. 1 cm (49 1/4" x 6 3/4" - d. 3/8")



**PANNELLATURA  
PDZ VENATA**

**PANNELLATURA  
PDZ LISCIA**

**E**UROSTYL



**T**ILESTYL **S**TARSTYL

I PANNELLI PER SOFFITTI  
ED I CONTROSOFFITTI

TILES FOR CEILINGS  
AND FALSE CEILINGS

**I**TALSTYL **E**UROSTYL **X**EXTRASTYL

**C**CLASSICSTYL **A**AMERICANSTYL

LE CORNICI, I ROSONI, LE TRAVI,  
GLI ANGOLI ED I FREGI

IN POLISTIRENE ESTRUSO, ESPANSO, POLIMERI ESPANSI,  
POLIURETANO E "POLISTRUTTURATO"

MOULDINGS, CEILING CENTRES, BEAMS,  
CORNER BLOCKS AND DECORS

EXTRUDED AND EXPANDED PS, EXPANDED POLYMERS,  
POLYURETHANE AND "POLISTRUTTURATO"



**P**ROFILSTYL

I PROFILI PER LA CASA  
TRIMMINGS

**B**BRICKSTYL

PROFILI PER L'ESTERNO  
EXTERIOR MOULDINGS

**O**BJECTSTYL

L'OGGETTISTICA  
PATCHWORK OBJECTS



I MANICHINI  
MANNEQUINS

**E**UROSTYL

LE COLONNE  
COLUMNS

**W**OODSTYL

LE TRAVI IN POLIURETANO  
POLYURETHANE BEAMS

**K**KRISTALSTYL

OGGETTI TRASPARENTI  
TRANSPARENT OBJECTS

per invio corrispondenza:

Bovelacci - Casella Postale 51, Uff. Post. Forlì succ. 8  
I-47100 Forlì - ITALY

per carico merci:

Bovelacci Cargo - Via Fiume Ronco, 2  
I-47100 Forlì - ITALY



**BOVELACCI**

Via del Commercio, 5  
I-47100 Forlì - ITALY  
Tel. +39 0543 721386  
Tel. +39 0543 811611  
Fax +39 0543 721127



I.P. Ufficio Marketing Bovelacci

Le caratteristiche tecniche indicate nel presente catalogo vengono fornite a titolo indicativo e potranno essere modificate senza preavviso. Non devono quindi essere considerate a scopo di specificità.  
The given values are indicative and can be changed without notice. They cannot be considered like a state.  
This leaflet and the designs embodied within are protected by copyright law and international treaties. Unauthorized reproduction of the leaflet or any portion of it or reproduction of any of the designs embodied therein may result in severe civil penalties and will be prosecuted to the maximum. All rights reserved, Bovelacci Forlì Italy.