



Quality and innovation for closing system



Arm stay **1**
1330SH/14 - 1330SH/16



Front fixed closing handle **2**
805 - 805.1

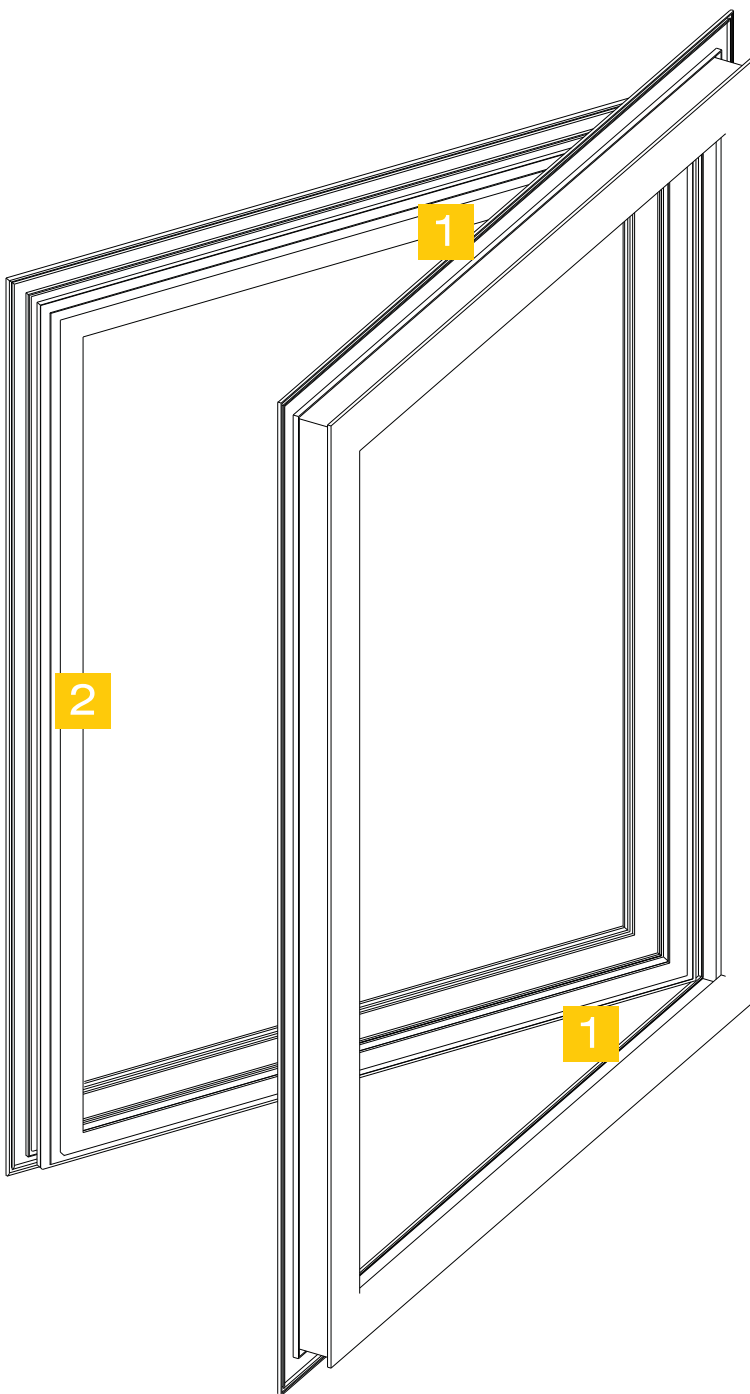

Single side hung external opening window



Arm stay 1
1330SH/20 - 1330SH/24 -
1330SH/28



Handle 2
876 - 879.2

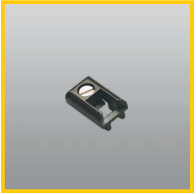

Keeper 3
1404



Internal mechanism 4
1475.9 - 1475.800



Terminal rod closing piece 5
1485 - 1486 - 1487.1

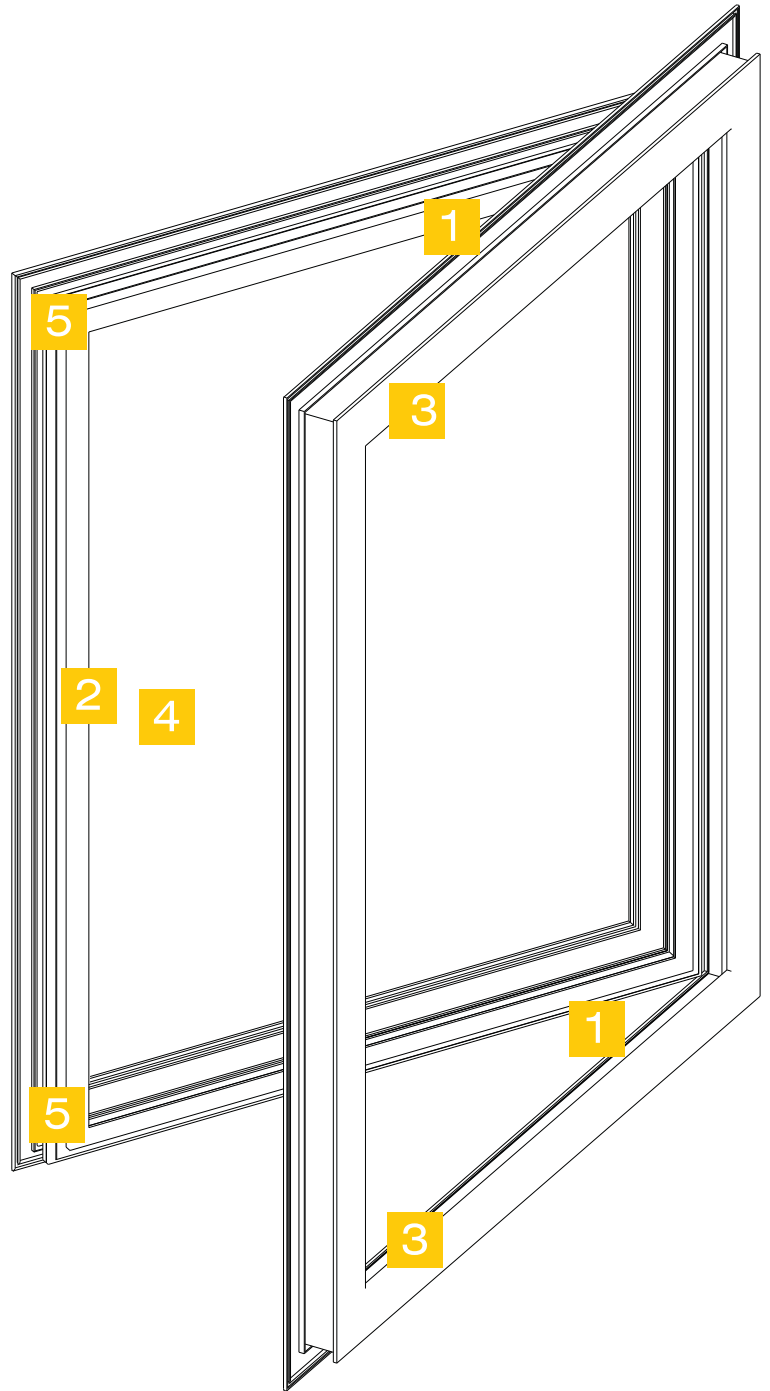



Arm stay 1
1330SH/20 - 1330SH/24 -
1330SH/28



Handle 2
876 - 879.2



Adjustable keeper 3
1243.721



Internal mechanism 4
1475.9 - 1475.800

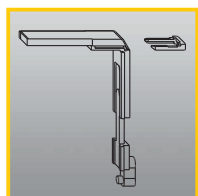

Corner device 5
1243.790



Terminal locking piece 6
1465

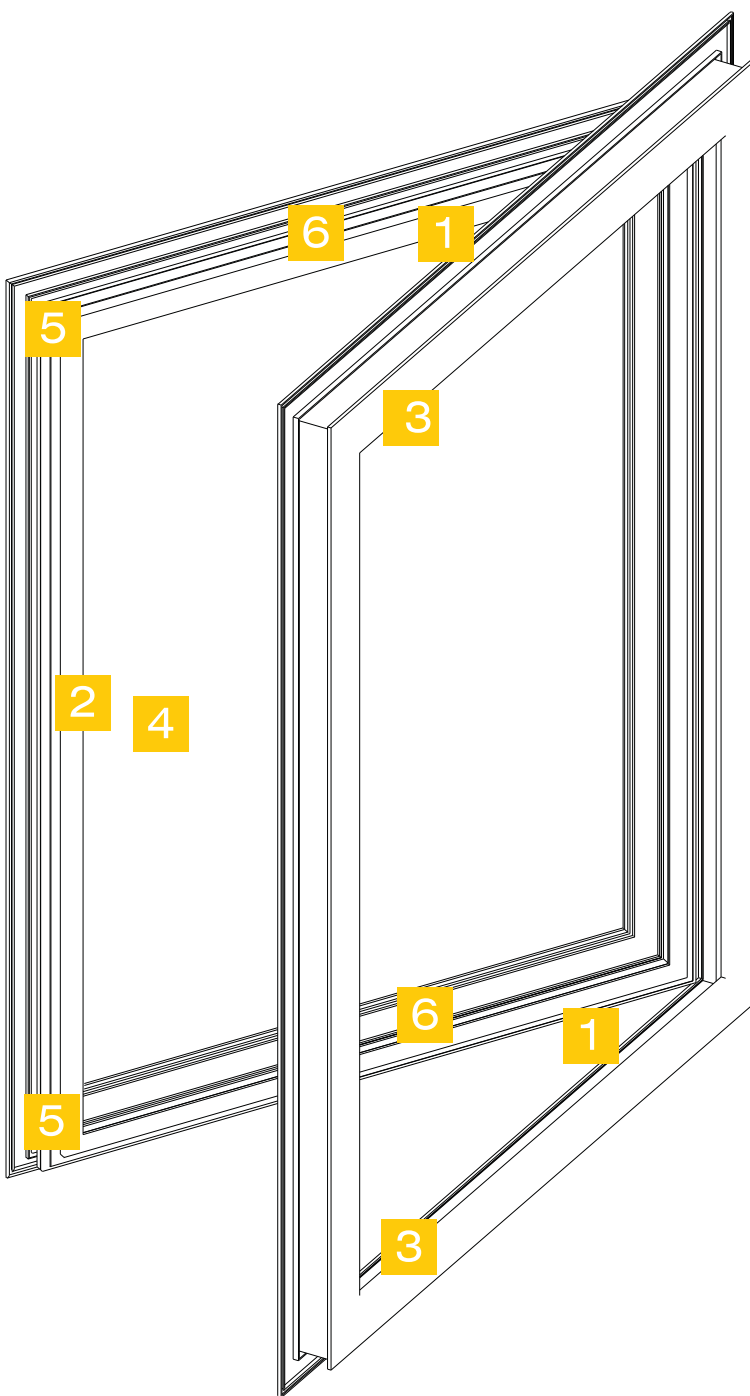

Double side hung external opening window



Arm stay 1
1330SH/20 - 1330SH/24 -
1330SH/28



Handle 2
876 - 879.2



Internal mechanism 3
1475.9 - 1475.800



Terminal rod closing piece 4
1485 - 1486 - 1487.1



Clamp bolt 5
1541.2



Extension rod 5
1541.802



Double keeper 6
1415 - 1416.5

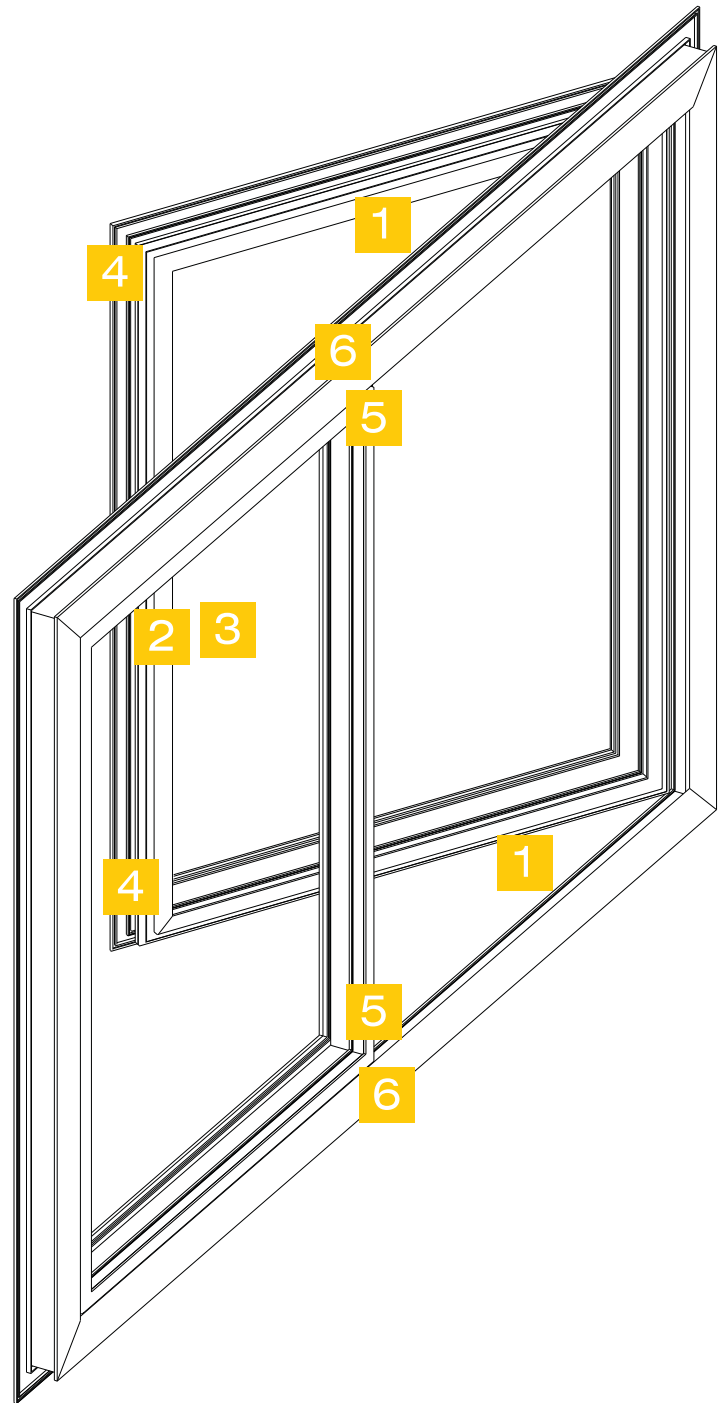



Handle 1
870.1 - 870.2 - 879.2



Hinge 2
1115 - 1121 - 1124.30



Double keeper 3
1414 - 1416.5 - 1404



Connection piece 4
1484.4 - 1481



Terminal rod closing piece 5
1485 - 1486 - 1487.1

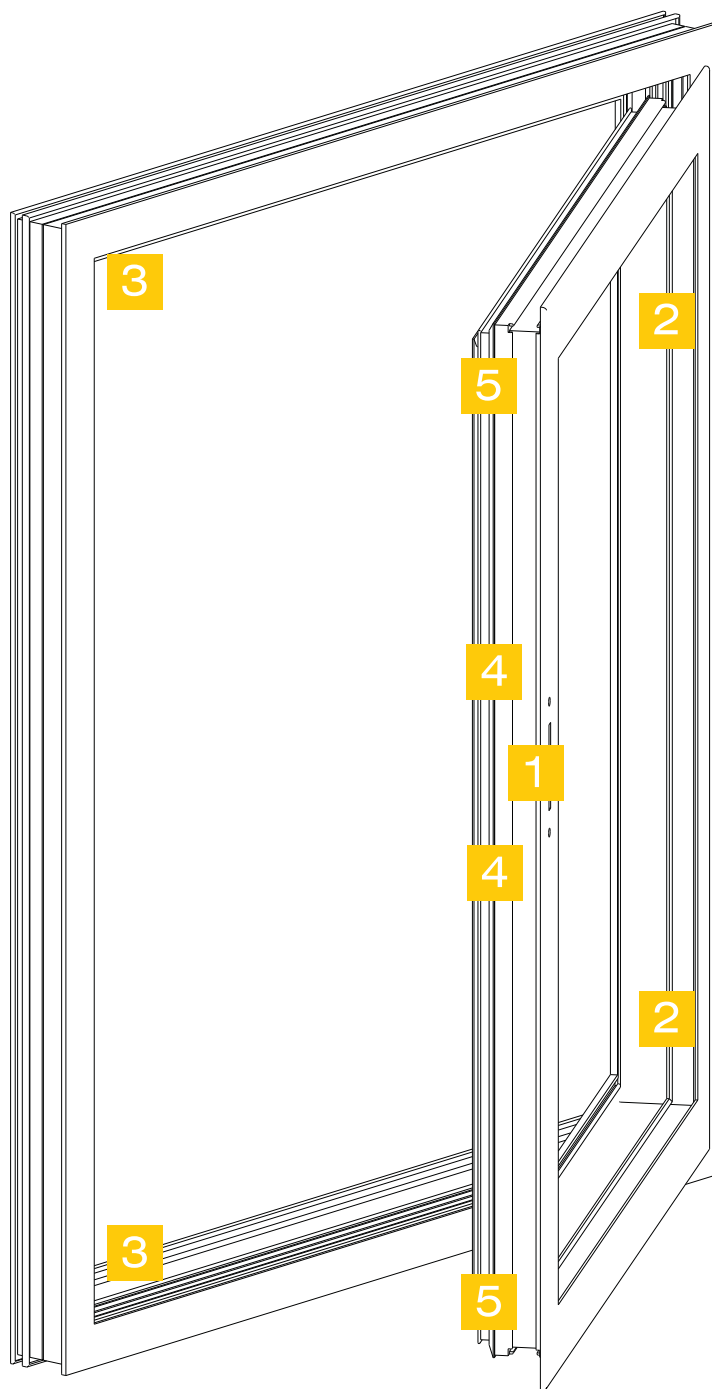

Double side hung window open in



Handle 1
870.1 - 870.2 - 879.2



Hinge 2
1115 - 1121 - 1124.30



Double keeper 3
1415 - 1416.5



Connection piece 4
1481 - 1484.4



Terminal rod closing piece 5
1485 - 1486 - 1487.1



Bolts 6
1541 - 3200.850



Extension part
1541.800

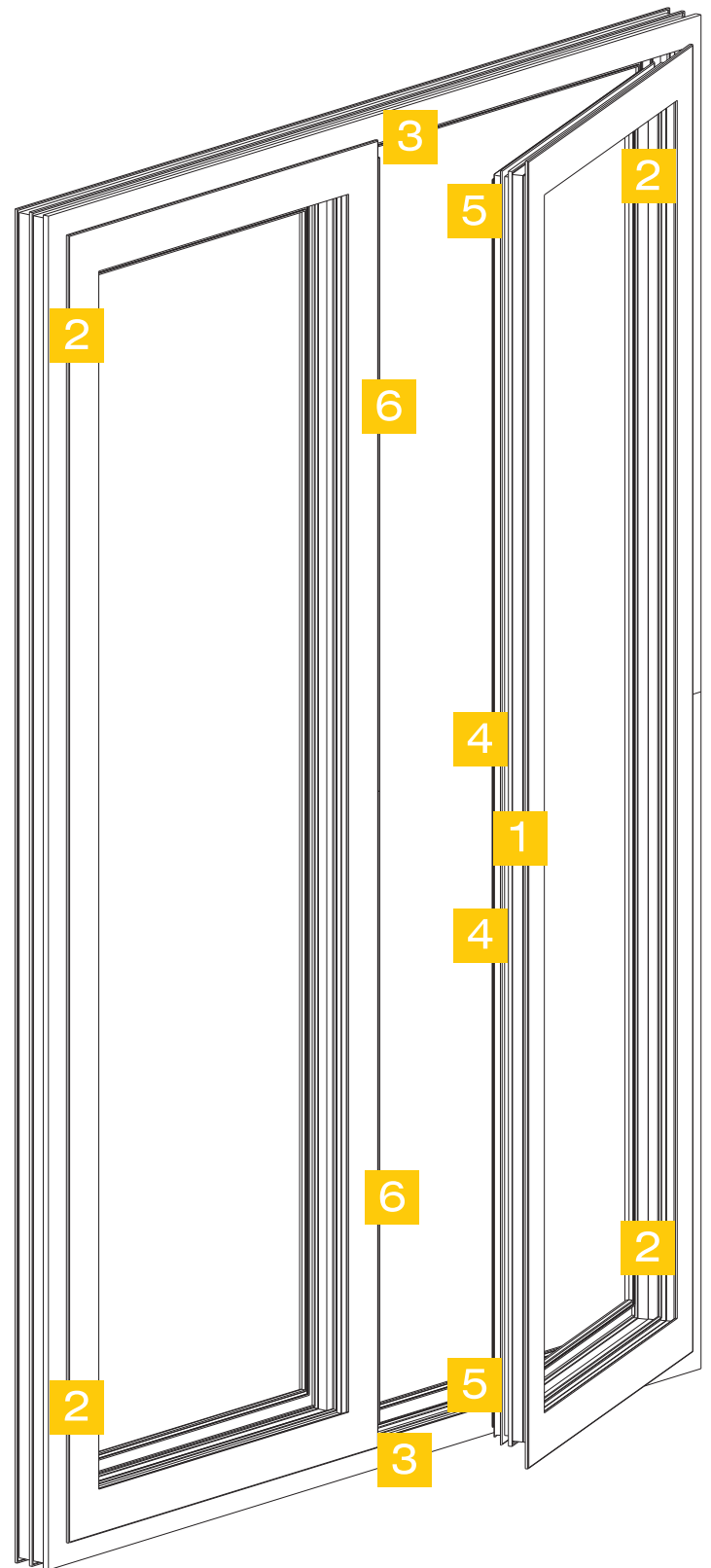



Catch 1
1360 - 1370.1 - 1390.1



Hinge 2
1115 - 1121



Arm stay 3
1341 - 1344

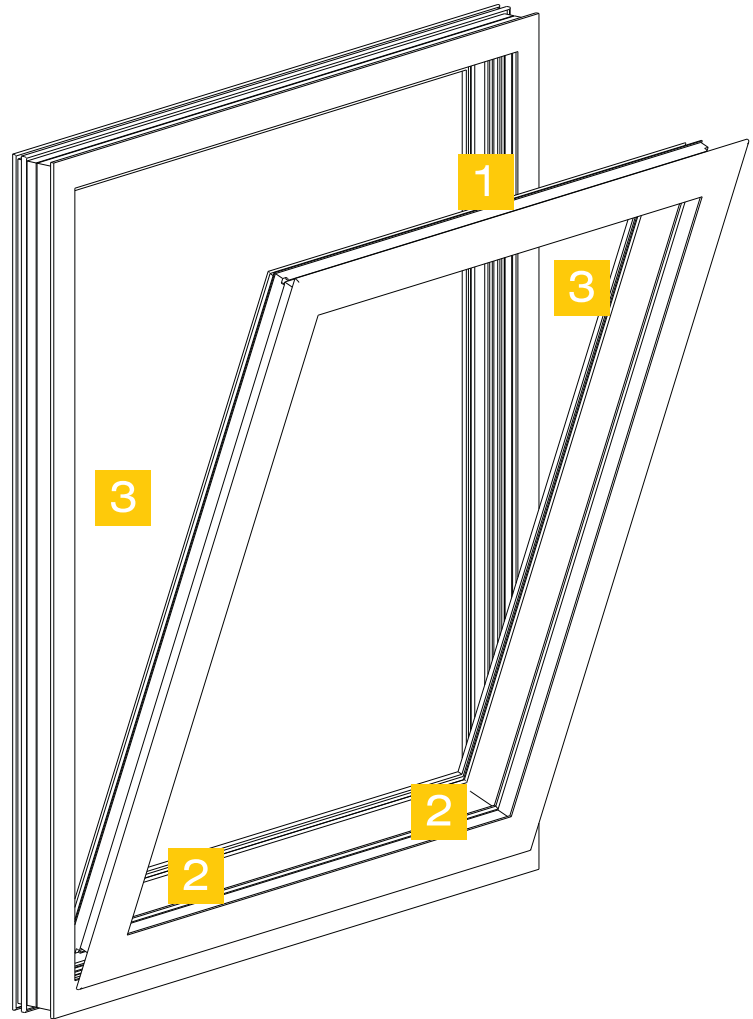



Hinge
1122 - 1122.200

1



Fanlight opener
F6 - F7

2



Fanlight opener
F6.R

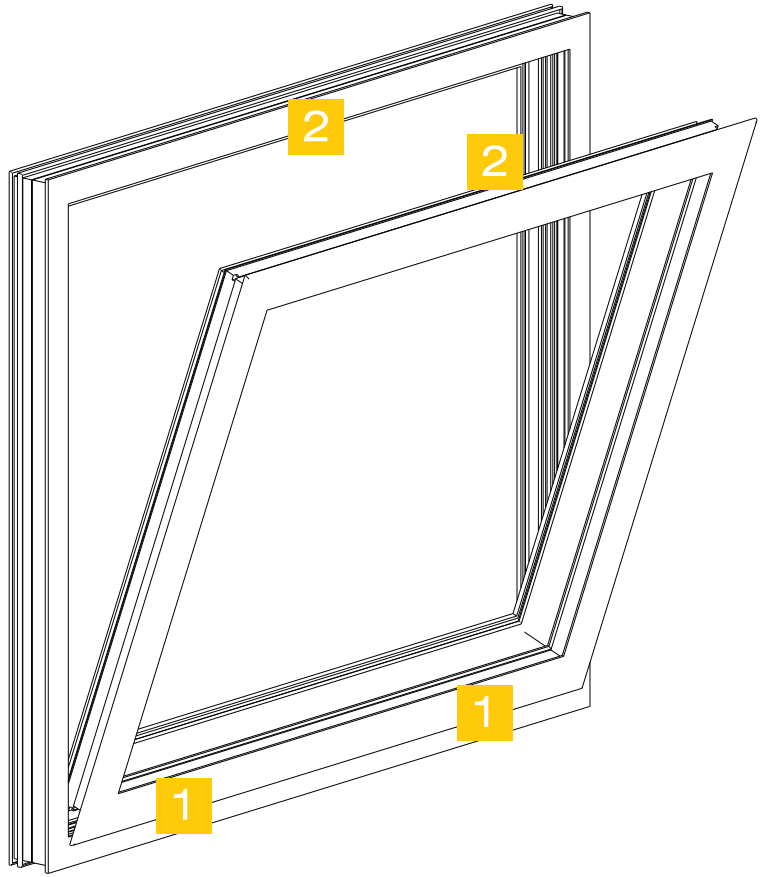



Arm stay 1
1330ST/14 - 1330ST/16



Height adjustment device 1
1330.801



Front fixed closing handle 2
805/.1

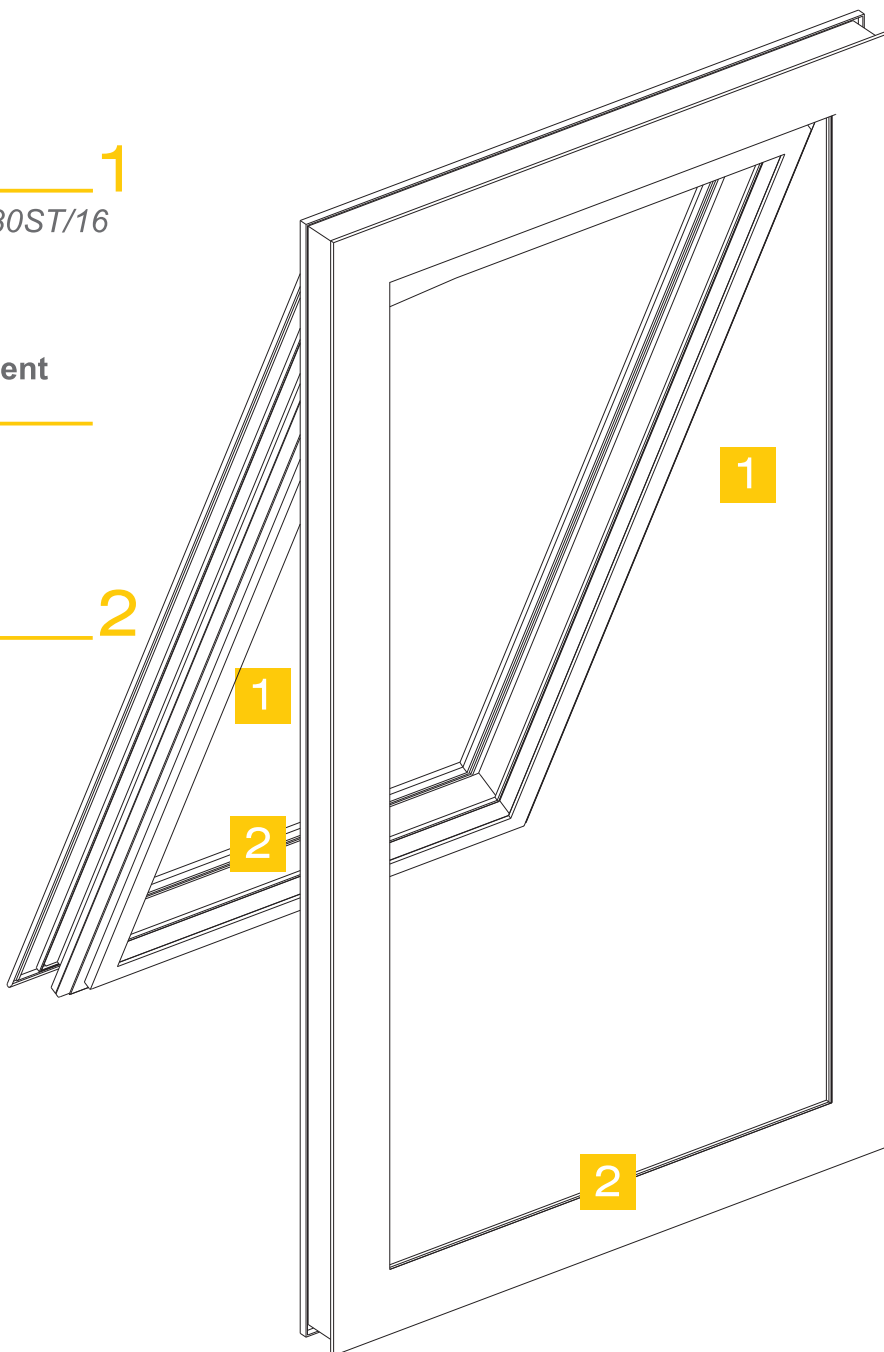

Top hung window open out (4 locking points)



Arm stay 1
1330HD/20 - 1330HD/24 -
1330HD/28



Height adjustment device
1330.801



Snap-latch 2
1609 - 1609.1



Bi-directional movement 3
1202/7

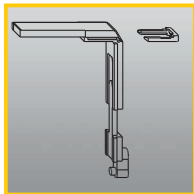

Corner device 4
1243.790



Terminal locking piece 5
1465



Adjustable keeper 6
1243.721

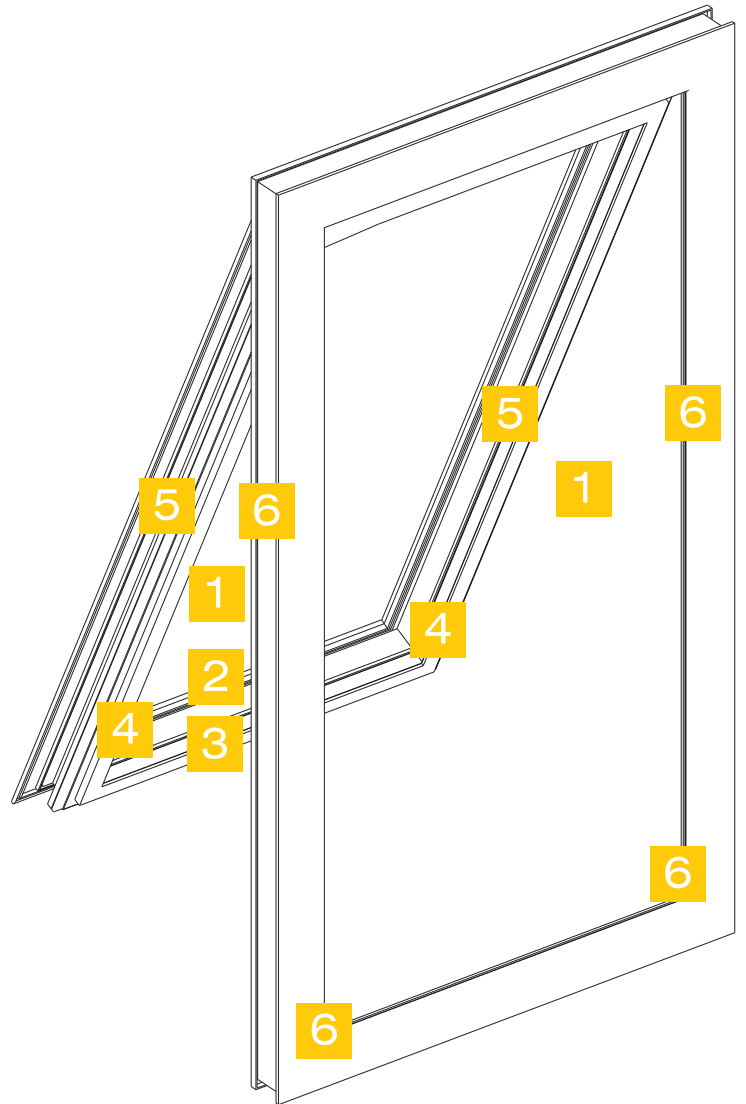

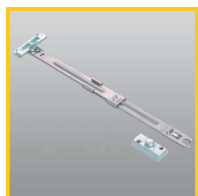

Arm stay 1
1341



Front fixed closing handle 2
805/1 - 806/1



Folding opener 2
1206.1/1 - 1206.1/2



Pivot hinge 3
1151.4 - 1151.XX

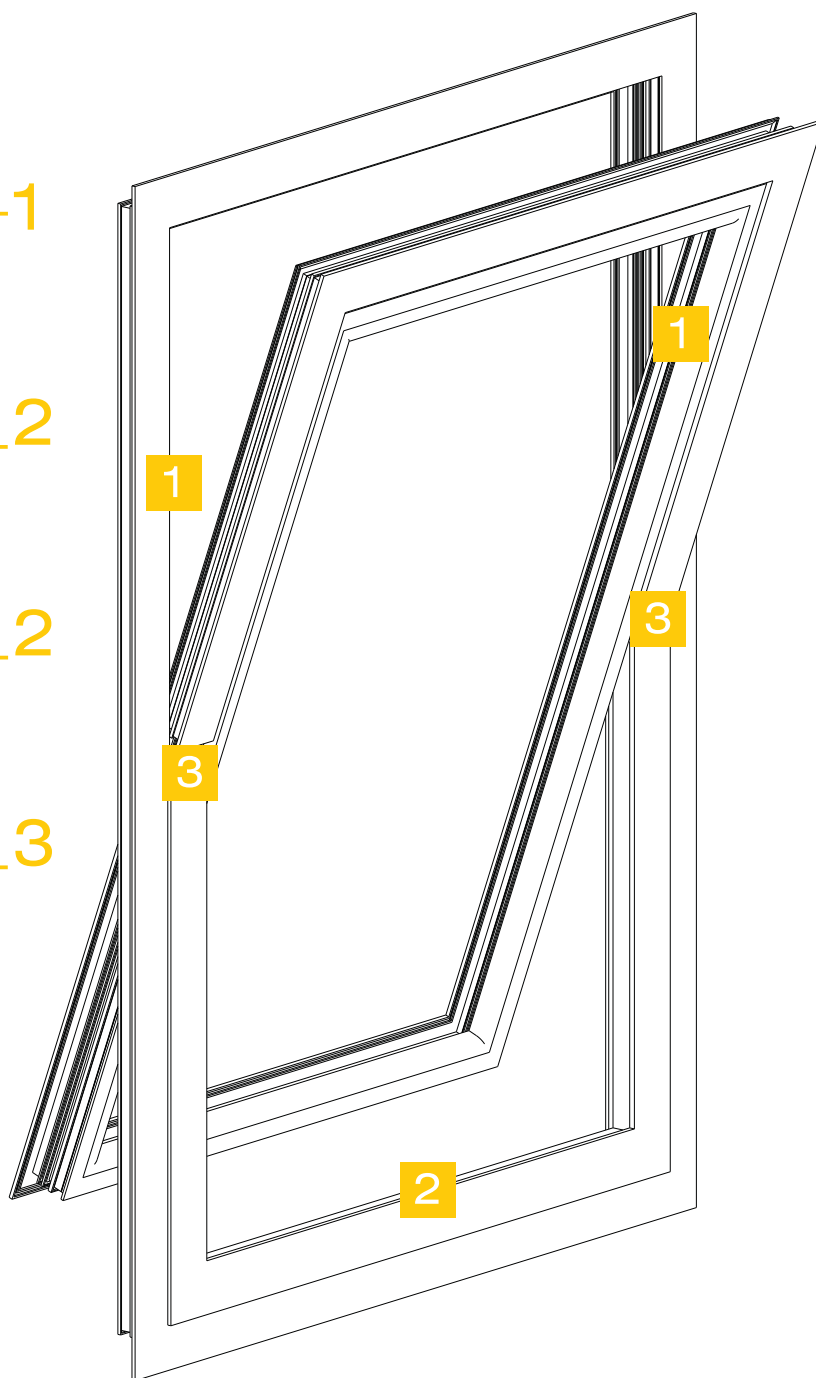

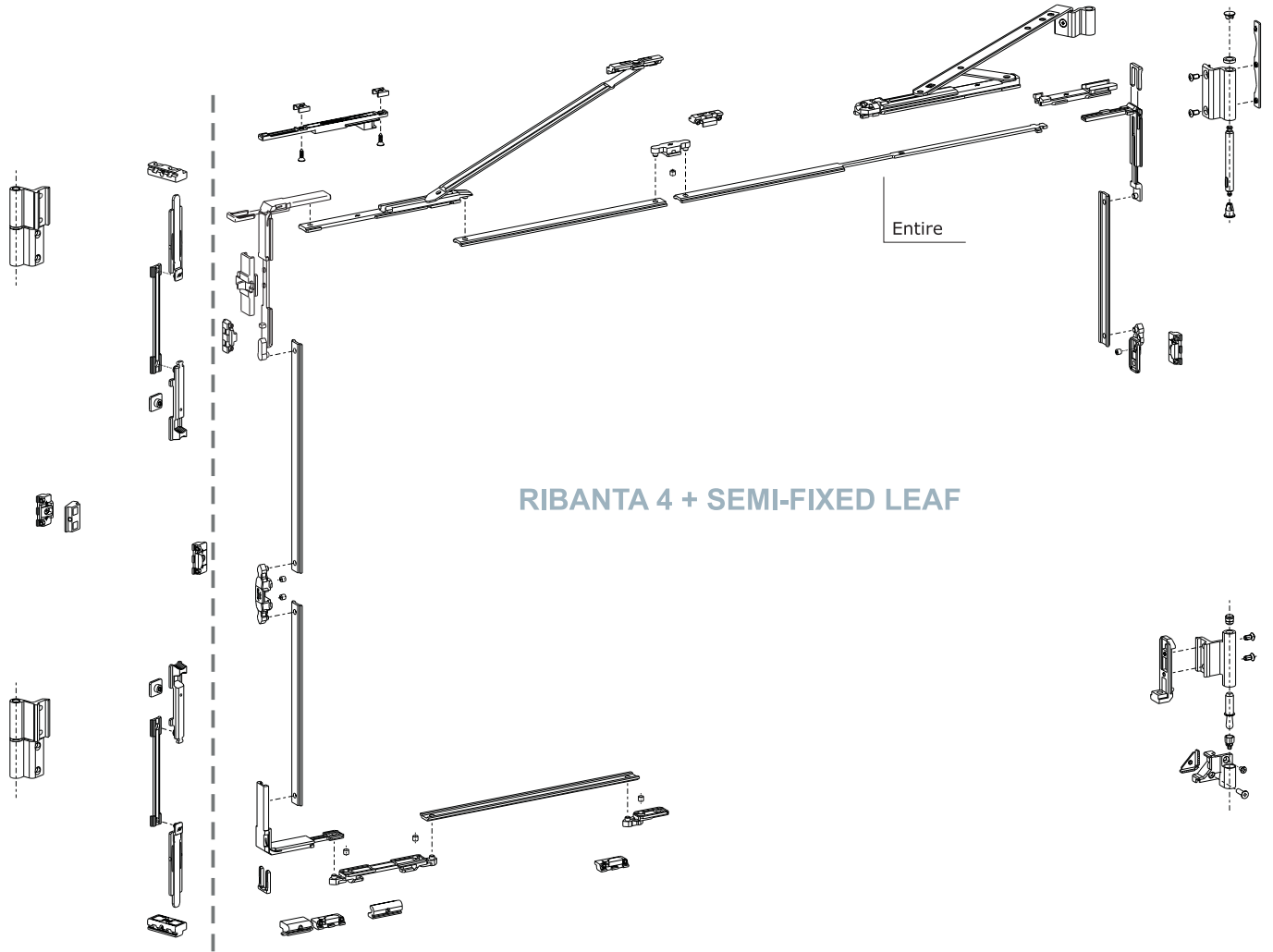

RIBANTA 4 + SEMI-FIXED LEAF

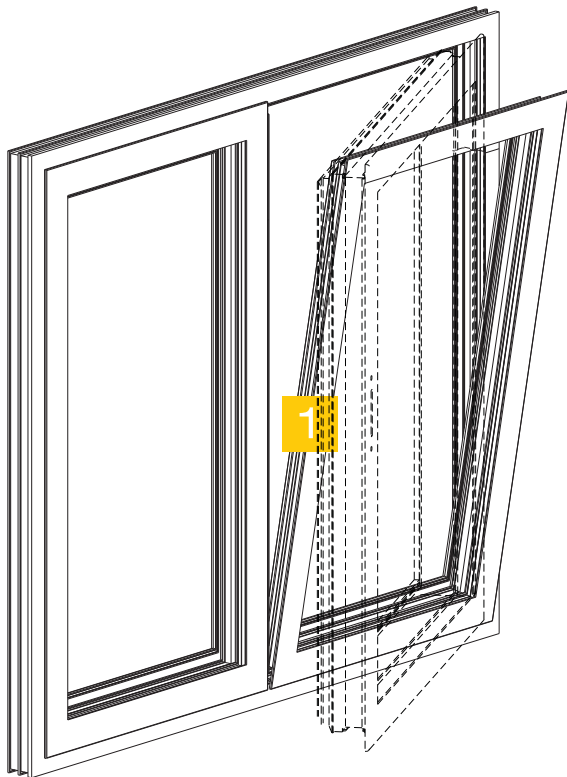

Handle
873.1 - 873.2

1

For article codes and components, please see SAVIO general documentation



Door handle 1
874.30/.31/.32 - 884



Escutcheon
874.801/.804



Hinge 2
1121 - 1122.200



Hinge 2
1124.30



Mortise lock 3
1852.19



Cylinder
1852.801

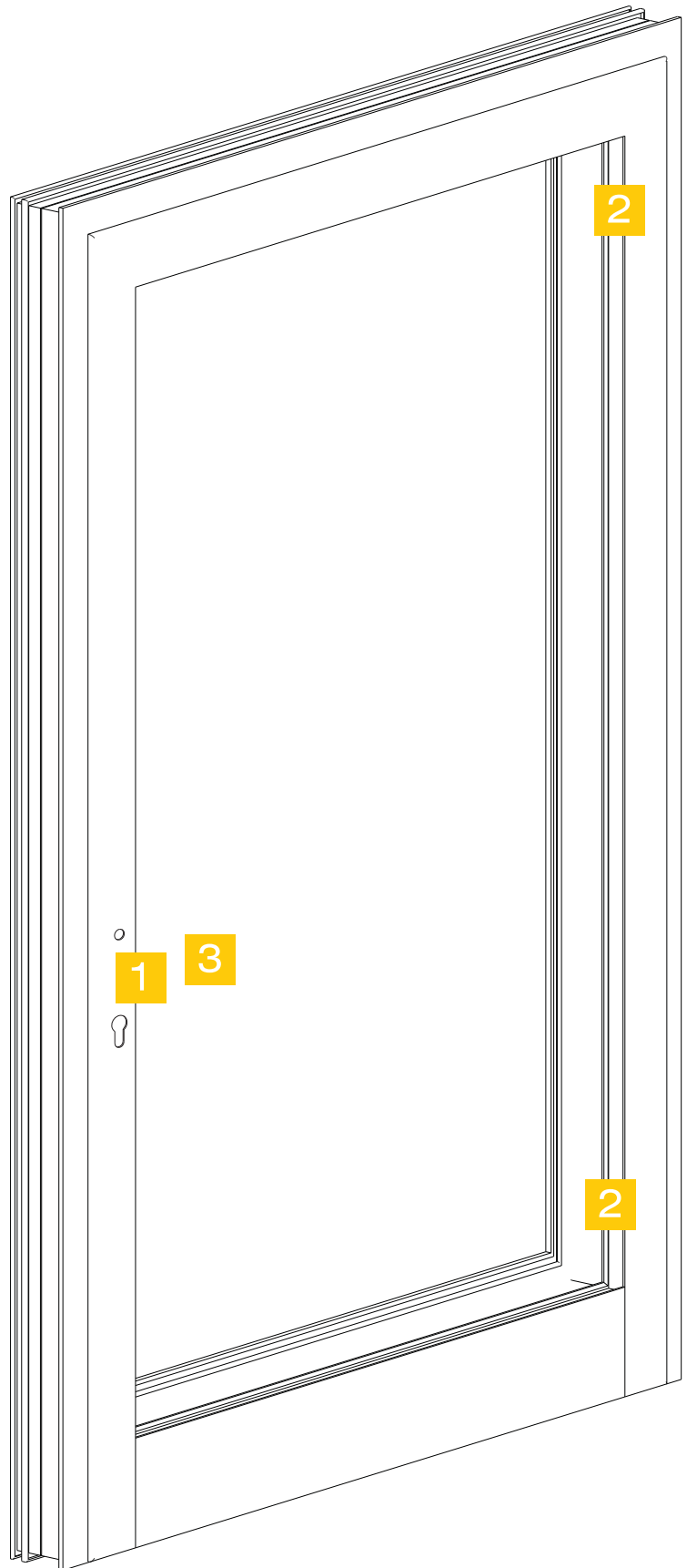

Double side hung door



Door handle 1
874.30/.31/.32 - 884



Escutcheon
874.801/.804

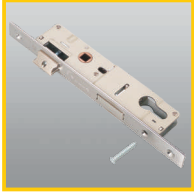

Mortise lock 2
1852.19



Cylinder
1852.801

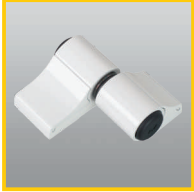

Hinge 3
1145/60 - 1145.3/60



Fastening Kit
1145.704/.714



Clamp bolt 4
1570/50 - 1572/50



Floor Keeper 5
1408

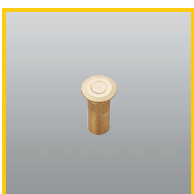

Powder-resistant floor Keeper
1409

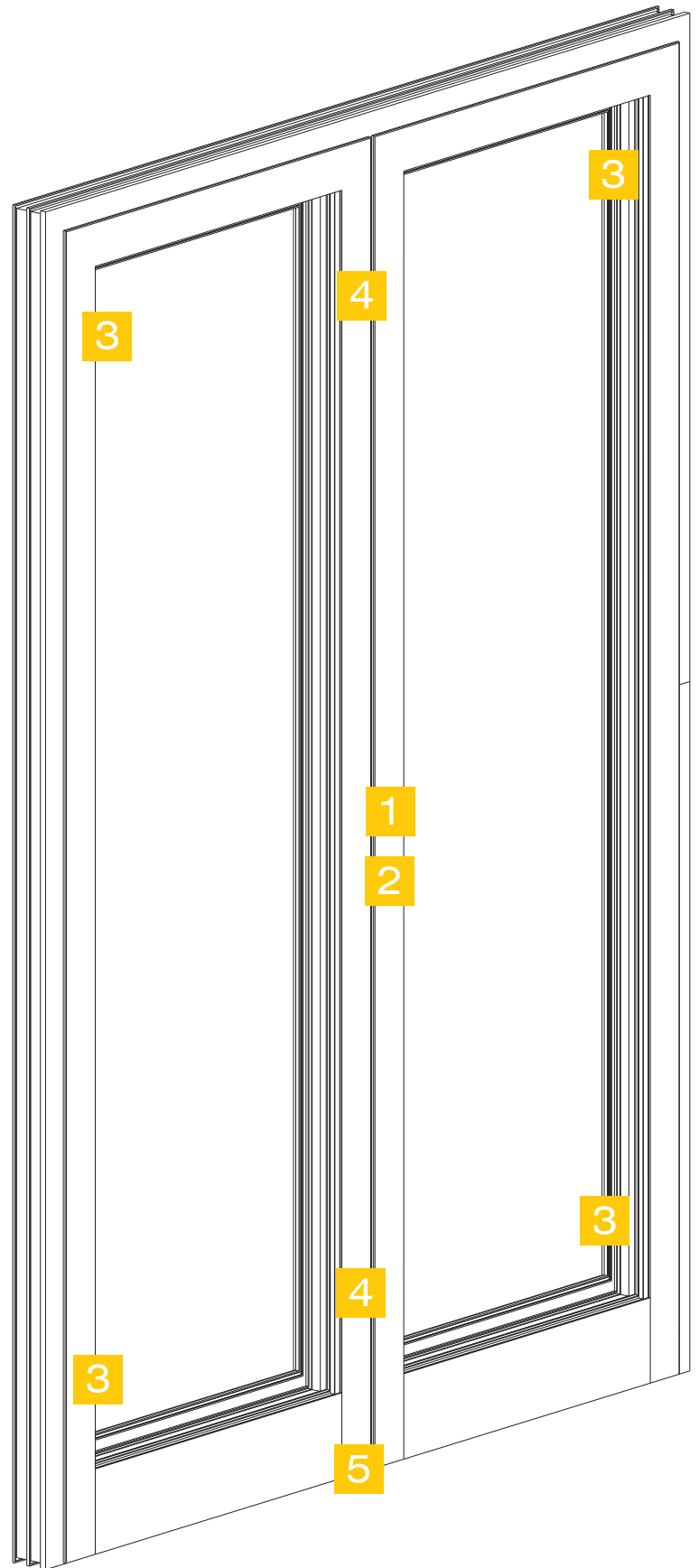



Lateral closing gear 1
2060.1



Automatic closing gear 1
2047 - 2048

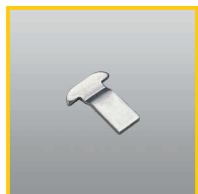

Locking piece 2
2050.XXX

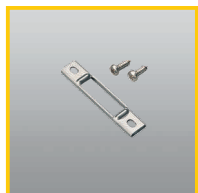

Keeper 3
2070.860



Closing Kit
2060.802



Fixed roller 4
2105 - 2110

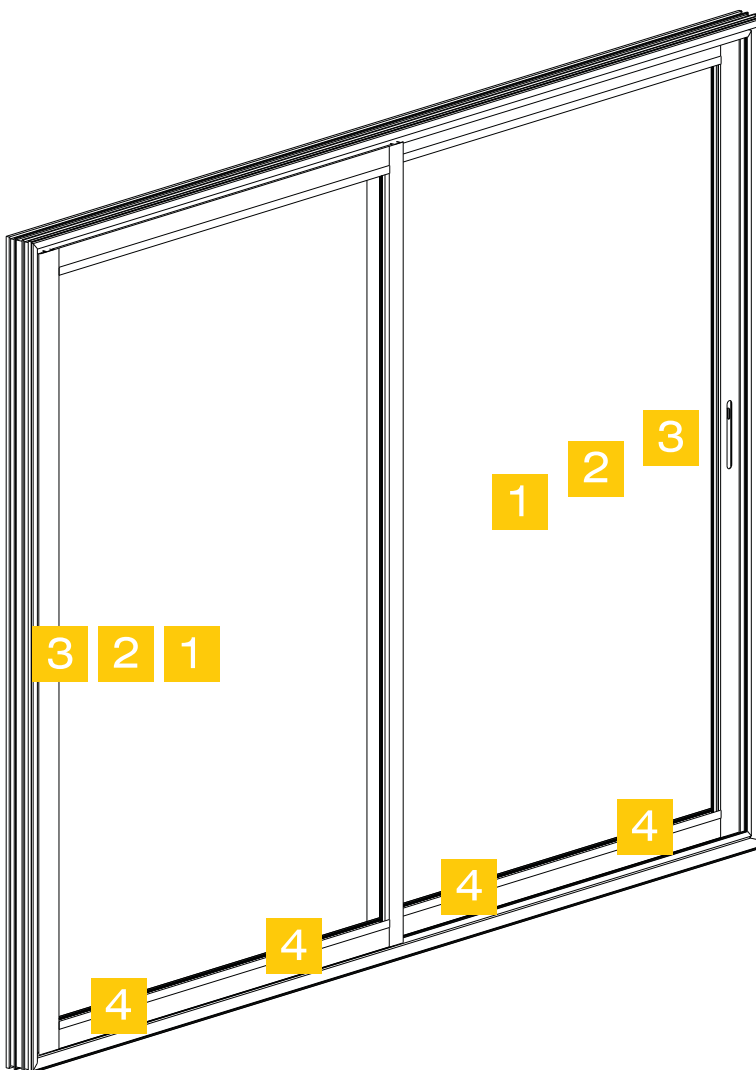

Double horizontal sliding door



Lateral closing gear 1
2070.1 - 2073.1

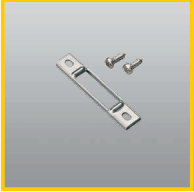

Keeper 2
2070.860



Locking piece 3
2070.835 or 2070.XXX



Pull handle 4
2080 - 2080.1



Fixed roller 5
2105 - 2110

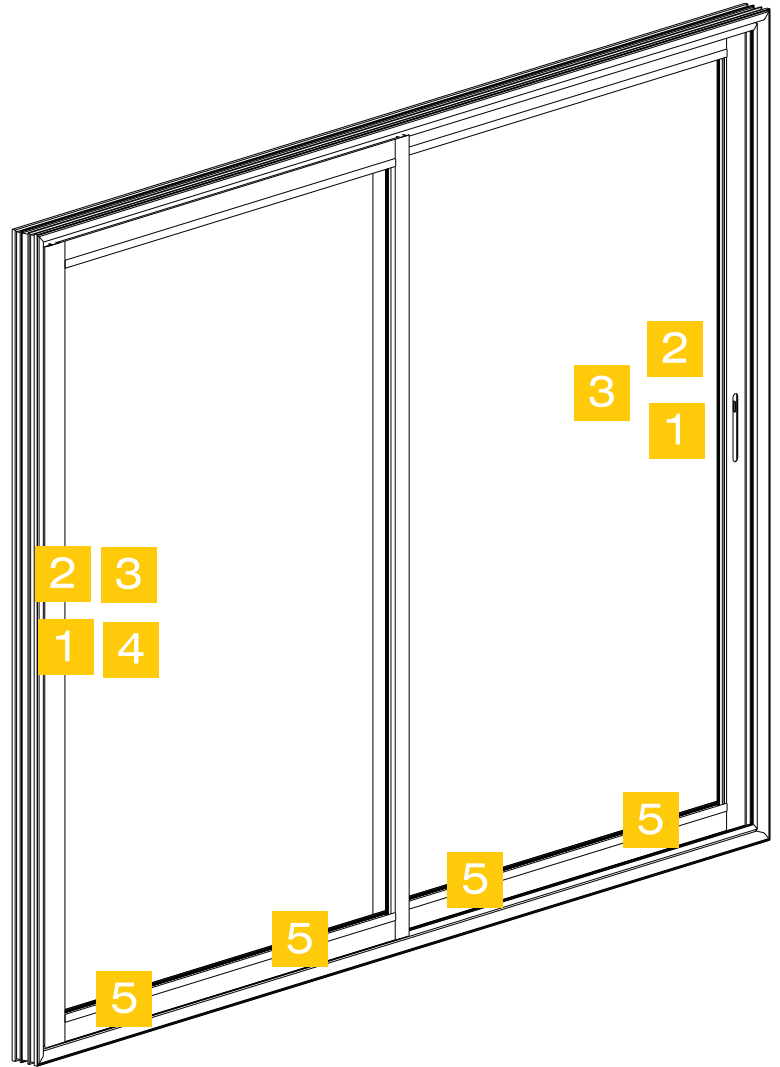

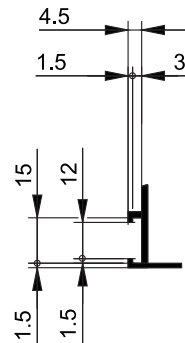
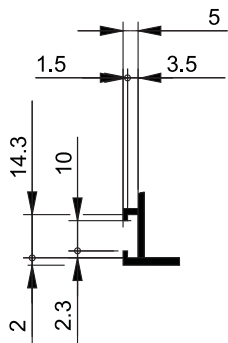
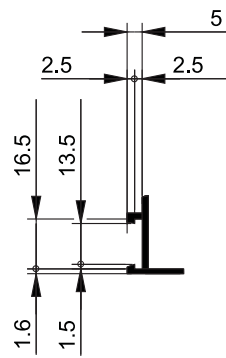
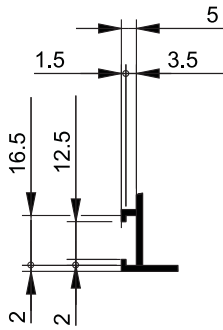
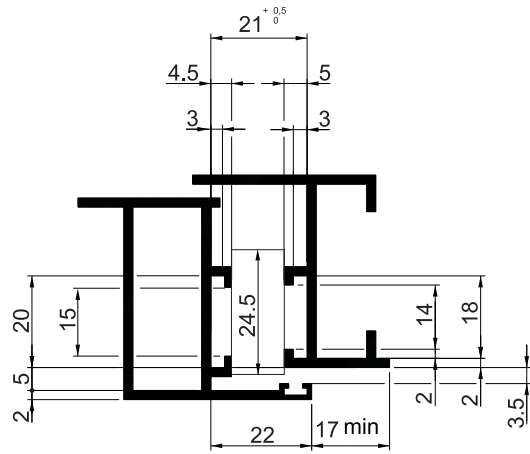



Application Type Solutions Catalogue